

SERVICE NEWS

A SERVICE PUBLICATION OF LOCKHEED AERONAUTICAL SYSTEMS COMPANY—GEORGIA



TROUBLESHOOTING HERCULES
AIR CONDITIONING

A SERVICE PUBLICATION OF
LOCKHEED AERONAUTICAL
SYSTEMS COMPANY-GEORGIA

Editor
Charles I. Gale

Art Director
Anne G. Anderson

Vol. 16, No. 2, April-June 1989

CONTENTS

- 2 **Focal Point**
I. R. Frewer
Program Manager,
C-13011-100 Engineering
- 3 **Troubleshooting Hercules**
Air Conditioning
- 13 **Preventing Shutoff Valve Thermal**
Expanding Damage
- 14 **Engine Rear Bearing Support and Tailpipe**
Failures
- 15 **RAAF Wins Top Honors in 1989 Airlift**
Rodeo

Photographic Support: John Rossino

Front Cover: The "Spirit of Wisconsin," first of the 440th TAW's eight new C-130Hs, flies over downtown Milwaukee.

Back Cover: Australia's champion airlift team celebrates its 1989 Airlift Rodeo victory (see page 15).

Service News is published by Lockheed Aeronautical Systems Company-Georgia, a unit of Lockheed Corporation. Information contained in this issue is considered by Lockheed to be accurate and authoritative; it should not be assumed, however, that this material has received approval from any governmental agency or military service unless it is specifically noted. This publication is for planning and information purposes only, and it is not to be construed as authority for making changes on aircraft or equipment, or as superseding any established operational or maintenance procedures or policies. The following marks are registered and owned by Lockheed Corporation:  "Lockheed," "Hercules," and "JetStar." Written permission must be obtained from Lockheed Aeronautical Systems Company-Georgia, before republishing any material in this periodical. Address all communications to Editor, Service News, Department 63-53, Zone 278, Lockheed Aeronautical Systems Company Georgia, Marietta, Georgia, 30063. Copyright 1989 Lockheed Corporation.

Focal Point



J.R. Frewer

Engineering a Modern Classic

Engineering has been defined as the systematic application of scientific principles in the design and construction of machines, structures, and systems useful to mankind's lifestyle. In the aerospace field, as elsewhere, few engineers today would agree that this definition adequately characterizes the work they do and the responsibilities they share. The special challenges that the men and women of Lockheed C-130/L100 Engineering's branch at LASC-Georgia are called upon to meet are unique.

Traditionally, the engineering effort applied to the design of a new aircraft has been able to assume a rather limited life cycle for the final product. The advent of the Hercules aircraft has changed all of this. There is no precedent for the Hercules aircraft. Nothing in the annals of modern aviation technology is remotely equivalent to the long-term success and continuing demand for this amazing airlifter.

The basic airframe of the Hercules has been solidly and conservatively engineered. It has proved exceptionally adaptable to further development as increased operational requirements continue to be formulated on this solid foundation. Not only has the airframe become structurally stronger, but advanced construction materials and manufacturing processes also ensure greater durability and lower maintenance costs, which is especially pertinent in the environments in which this airplane is required to operate.

Against this background, it should come as no surprise that this well-designed basic structure has also proved highly adaptable to the diverse needs of a wide variety of aircraft operators. Today, more than 50 distinct versions of the Hercules airlifter are doing the world's work in every corner of the globe, each one carefully engineered to the customer's needs, and optimized to perform its intended mission.

As everyone knows, the aerospace industry has made some rapid advancements in both performance and reliability. The Hercules has proved similarly adaptable as these new technologies have emerged to replace the old, allowing its users to enjoy the benefits of the latest technical advances in their aircraft. Hercules operators are able to choose from a wide selection of state-of-the-art avionics navigational system equipment designed to meet the specific needs of their particular mission profiles.

Today's technology continues to generate a "rolling wave" effect in the Hercules Production Program. Development work has already been initiated to apply these latest advancements in technology, which would include such features as the electronic flight instrument system ("glass" cockpit), digital autopilot, and self-contained navigation system, along with a host of other updates and improvements. The major impact of these changes would reduce crew member component requirements and associated maintenance manpower, greatly reducing cost of ownership for the customer.

When the first Hercules aircraft rolled off the assembly line, it was built for the future, and this has proved to be true. We, Lockheed C-13011-100 Engineering, take special pride that the same is still true for every Hercules we build today. We intend to ensure, through support of our Manufacturing organization and our customers, that this continues in the future.

Sincerely,

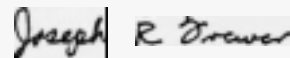

J. R. Frewer, Program Manager
C-130/1-100 Engineering
Lockheed Aeronautical Systems Company

PRODUCT SUPPORT LOCKHEED AERONAUTICAL SYSTEMS COMPANY-GEORGIA

H.L. BURNETTE DIRECTOR

FIELD SUPPORT

SUPPLY SUPPORT

TECHNICAL PUBLICATIONS

RELIABILITY MAINTAINABILITY SUPPORTABILITY & TRAINING

J.D. ADAMS

D.R. STEELE

C.E. ADAMS

H.M. SOHN

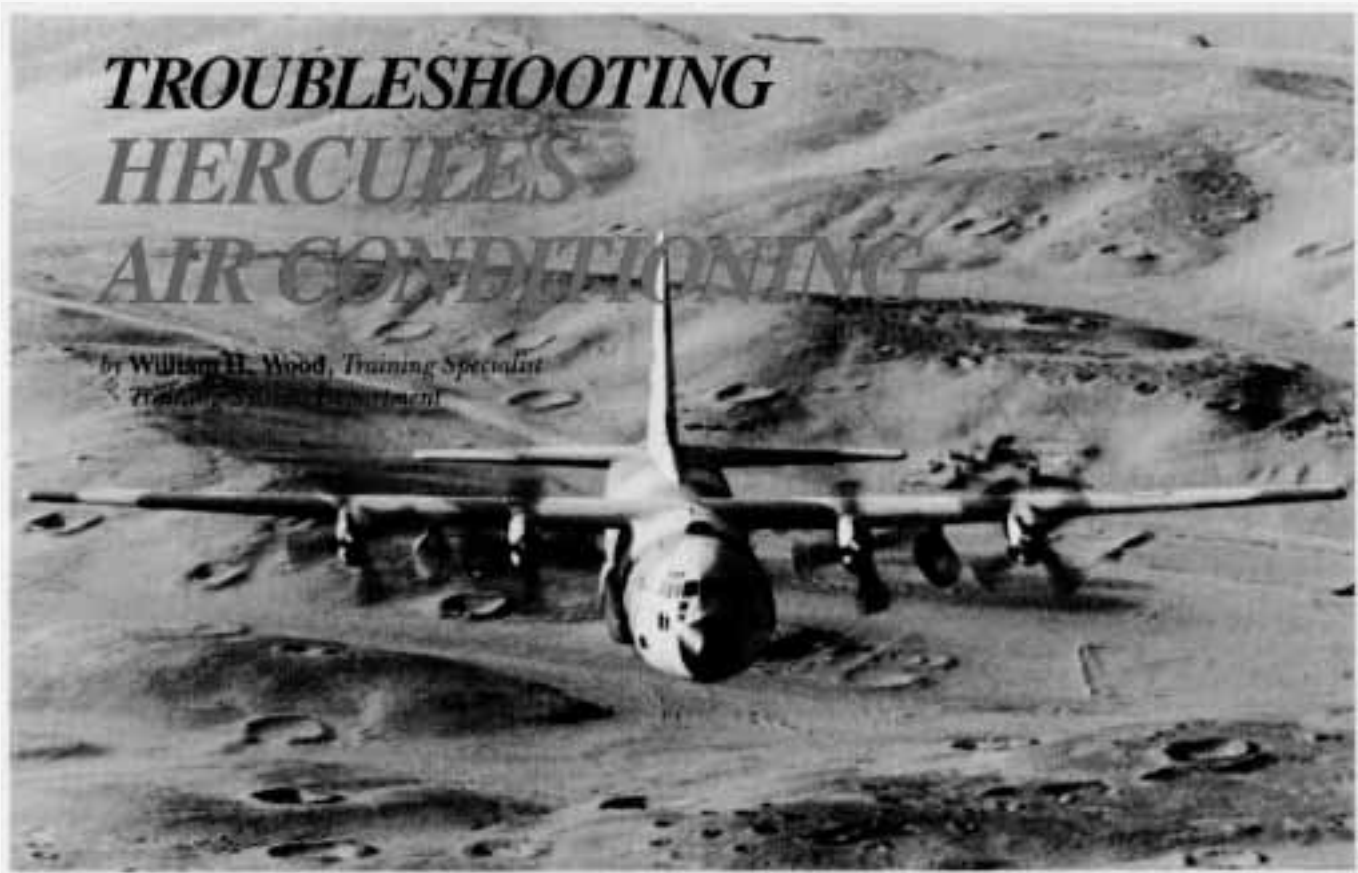

A versatile, modern aircraft like the Hercules airlifter must be equipped to provide a safe and comfortable cabin environment under all operating conditions, at all times, everywhere.

It is instructive to consider just how demanding such a requirement can be. The outside air temperatures at the altitudes where today's aircraft routinely operate are commonly 60 or 70 degrees below zero Fahrenheit. Yet the same airplane that is expected to maintain a warm, pressurized environment for its passengers and crew during high-altitude flight must also be able to provide air-conditioned comfort at the destination airport, where the temperature may be 100 degrees above the zero mark.

An air conditioning system that can provide a comfortable interior climate over such a wide range of conditions must be an effective one indeed. The Hercules not only has an air conditioning system designed to meet these environmental challenges, it has two.

Hercules Environmental Control

Each Hercules aircraft is equipped with two separate air conditioning systems, one for the cargo compartment and one for the flight station. The capability of the two systems and the equipment they contain are identical for all practical purposes.

The major components of the cargo compartment system are located in the forward part of the right wheel well. In the case of the flight station system, most of the components are under the flight station on the right side of the aircraft.

Both systems may be used at the same time, or either can function individually. At sea level, each system can provide about 70 pounds per minute of conditioned air through its associated distribution ducts.

This air can be used to maintain interior temperatures at the desired levels, provide cabin pressurization, and furnish ventilation. When operated simultaneously, the two systems can maintain 7.5 degrees F inside the aircraft when the outside temperatures are in the range from -65 to +100 degrees F.

System Basics

Efficient troubleshooting of air conditioning problems begins with a good, fundamental knowledge of system design. With this in mind, let us review in simplified form the basic components contained in the Hercules air conditioning systems, their relationship to each other, and the operation of each system as a whole.

In this discussion we will address mainly the cargo compartment system; however, the same information can

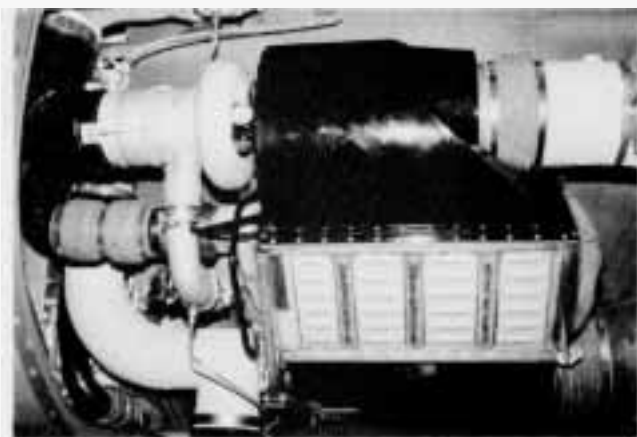

Cargo compartment air conditioning unit, forward right wheel well fairing.

also be applied to the flight station system since the operation of both systems is identical and most of the components are interchangeable.

The following information deals primarily with the new air conditioning systems installed as a production change on LAC 4653 and up, except for the U.S. Marine Corps, for whom the new systems were installed on BUN0 160625 and up. These changes were also incorporated on LAC 4579 through 4652 on aircraft sold to the USAF Greece, Spain, and Nigeria.

A new solid-state temperature control system was installed as a production change on aircraft beginning with LAC 4579. This new temperature control system can be

installed on aircraft with the old air conditioning system provided **all** the system components listed below are changed:

- Temperature control box
- Compartment temperature sensor
- Duct anticipator sensor
- Duct high-limit (overheat) sensor
- Temperature selector rheostat

Cargo Compartment System

The air which exits from the conditioned air outlets starts out as bleed air from the engines at a temperature of about 600 degrees F, or from the APU at about 400 degrees F. This air is ducted through the flow control and shutoff valve to an air-to-air heat exchanger and from there to a mixing valve which is used for temperature control (see Figure 1).

In the heat exchanger, the bleed air is cooled to a temperature of about 140 to 200 degrees F by a cross flow of ambient air. This partially cooled air is ducted to an expansion (cooling) turbine and to a bypass valve (low-limit valve). The cooling turbine is capable of reducing the temperature to well below freezing; however, an automatic control system provides a low-temperature limit of about 37 degrees F by bypassing some partially cooled air around the turbine.

This cold air is ducted through a water separator to the conditioned air supply duct and then to the distribution ducts overhead in the cargo compartment. Compartment temperature is controlled by mixing hot air with the cold air

Figure 1

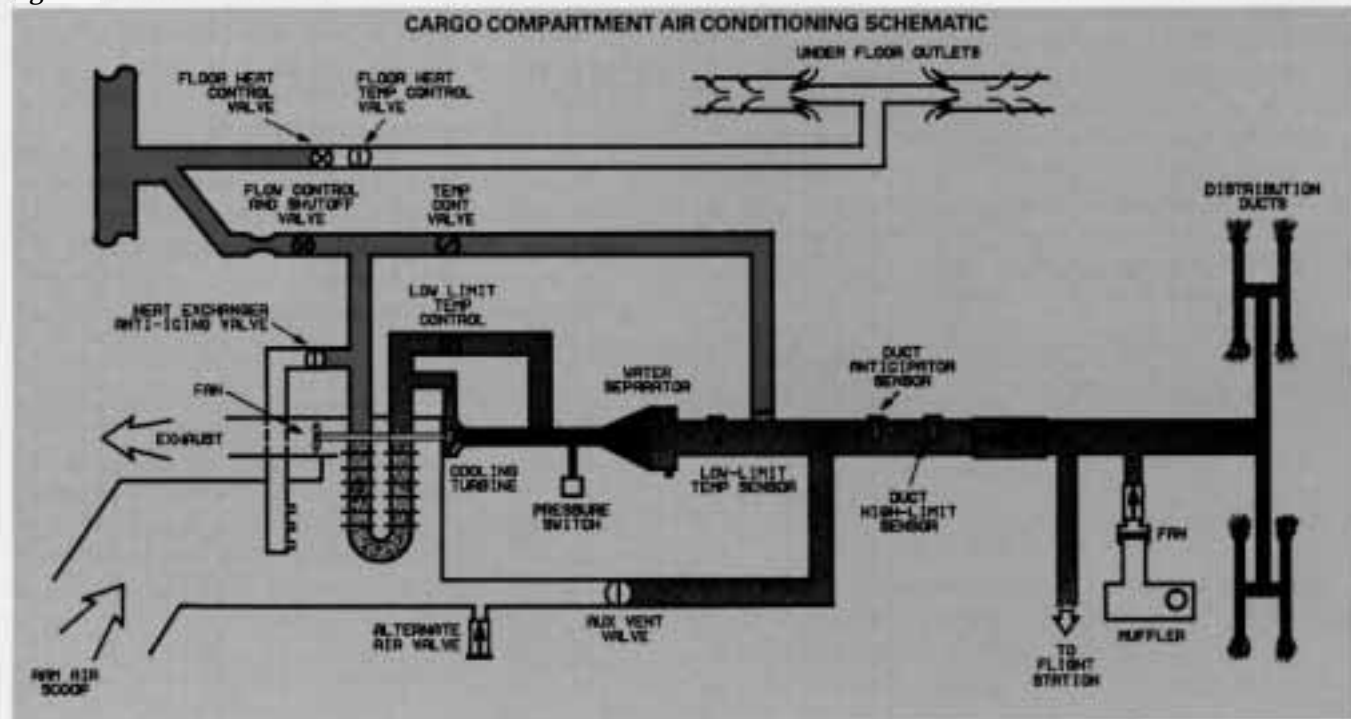

coming from the water separator. The temperature control valve regulates this mixture. Automatic and manual control systems are provided to operate the valve.

Heat Exchanger Anti-Icing System

On aircraft prior to LAC 4947, the refrigeration unit is equipped with a hot air anti-icing system for the heat exchanger. Controls and indicators for the anti-icing system are contained on a small panel located just to the right of the overhead anti-icing control panel in the flight station.

If the heat exchanger ices up, resulting in a significant reduction in cooling air flow, there will be an appreciable rise in the heat exchanger cooling fan discharge duct temperature. A temperature sensor installed in the discharge duct will detect this condition and illuminate an amber warning light on the control panel.

Placing the control switch to the ON position opens the anti-icing valve to supply hot air from the bleed air inlet of the heat exchanger to a spray tube in the cooling air inlet plenum. A green light on the panel illuminates to indicate that the valve has opened.

When the ice melts and cooling air flow is again established, the amber light will go out and the system can be turned off. If the amber light does not go out within 30 seconds, it means that the obstruction is caused by some substance other than ice and the affected air conditioning system must be shut off.

Aircraft LAC 4947 and up do not have this heat exchanger anti-icing system. These airplanes are equipped with a heat exchanger of different design which is not susceptible to icing, thus eliminating the requirement for anti-icing.

Water Separator Low-Limit Temperature Control System

Since the refrigeration unit is capable of producing air temperatures below freezing, a low-limit temperature control system is required to maintain the air temperature above freezing in order to prevent icing of the water separator.

Partially cooled bleed air from the heat exchanger bypasses the cooling turbine through the low-limit valve and mixes with the cold air output from the turbine. A temperature control box operates the valve in response to signals from a temperature sensor installed in the water separator outlet duct.

The valve is driven open or closed to provide more heat or less heat as required to maintain a temperature of approximately 37 degrees F at the output of the water separator. The valve is driven in pulses in order to minimize overshooting.

Whenever the air conditioning master switch is positioned to OFF, a relay is energized which disconnects the control box outputs from the valve and applies power to drive the valve fully open. This is done to reduce the starting shock load on the turbine bearings the next time the system is turned on. When the system is turned on, the valve will pulse toward closed as air flows through the system.

Failure of the low-limit system may result in icing of the water separator, restricting airflow. As airflow decreases, duct pressure on the inlet side of the water separator increases. This pressure is sensed by a pressure switch. If the pressure reaches approximately 14 psi differential, the pressure switch actuates to energize a relay, which then energizes the flow control and shutoff valve closed.

This shuts off the air conditioning system, and a holding circuit on the relay keeps the system shut off until power is removed from the circuit. The normal way to reset the system is to turn the master switch off and then back on. However, since this action will momentarily shut off the other air conditioning system also, a pressure bump can be expected if the aircraft is pressurized.

If the system is reset and then shuts off again, it is best to leave it shut off until the problem can be isolated and corrected.

Compartment Temperature Control

Compartment temperature control is accomplished by allowing bleed air to bypass the refrigeration unit and mix with the cool air from the water separator. The hot air is added into the conditioned air supply duct downstream from the water separator. The amount of hot air bypassed is

Temperature control boxes, aft side of FS 245 bulkhead

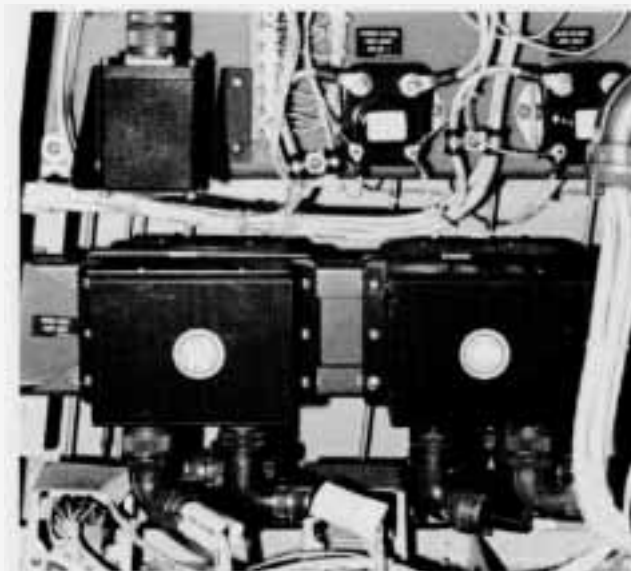

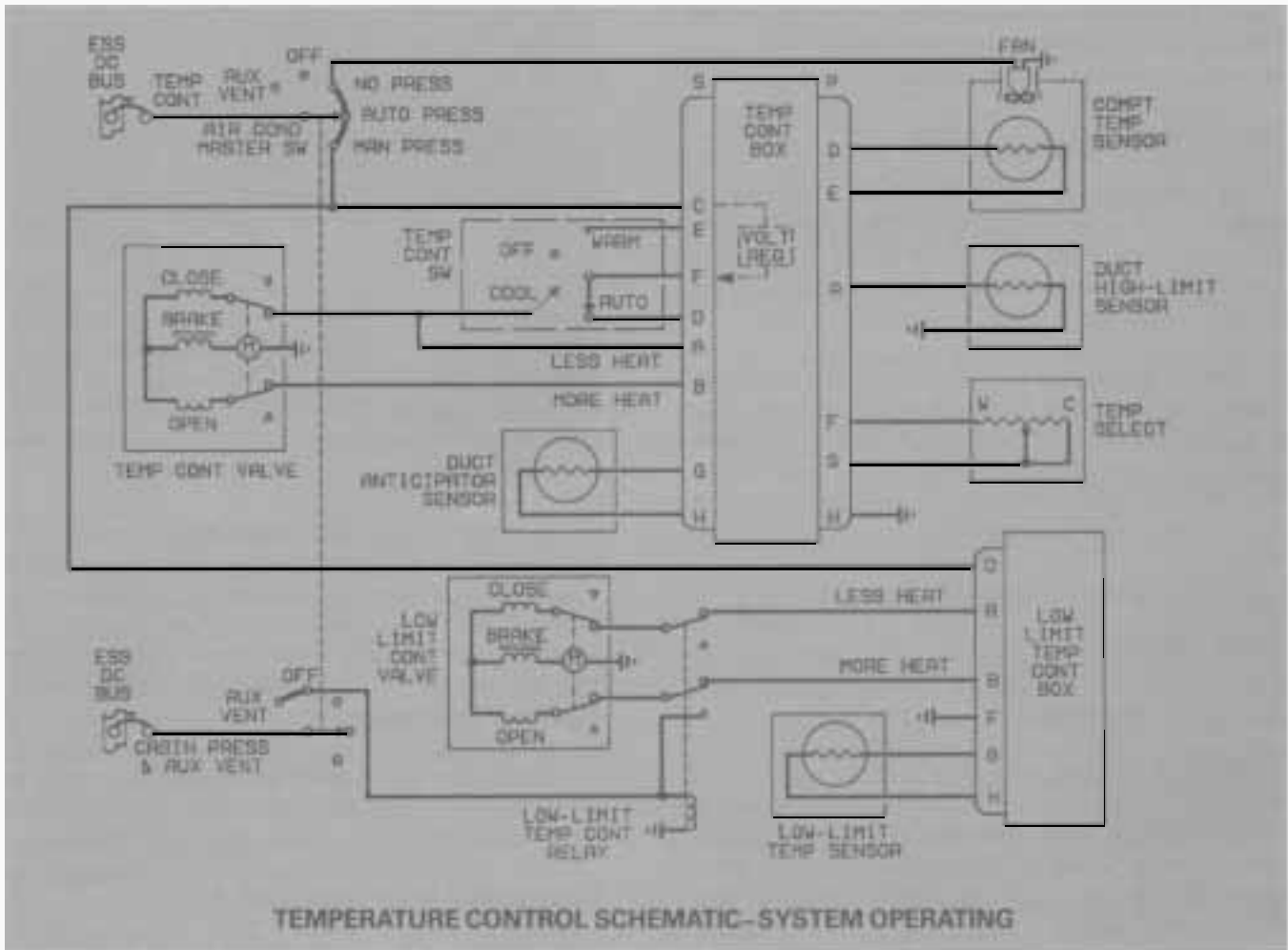

Figure 2

regulated by the temperature control valve. Both manual and automatic controls are provided for operation of the valve.

Automatic Temperature Control

Figure 2 shows a schematic of the temperature control system. In automatic operation, the valve is positioned by outputs from a temperature control box in response to signals from three temperature sensors and a temperature selector rheostat. These function as follows:

- The **temperature selector rheostat** serves as the system's basic control. It establishes the temperature level which the system must maintain. The selectors for both flight station and cargo compartment systems are located on the overhead air conditioning control panel in the flight station.
- The **compartment temperature sensor** functions as the primary sensing unit for temperature control. It provides actual compartment temperature information to the control box. The cargo compartment unit is located on the

left side of the cargo compartment at fuselage station 357. The flight station unit is located at the right aft corner of the overhead control panel.

- The **duct anticipator sensor** is sensitive to temperature change. It helps to control the driving time of the temperature control valve to prevent overshooting. The anticipator sensor is installed in the conditioned air supply duct downstream from where the cool air from the water separator and hot bypass air are mixed.
- The **duct high-limit sensor** is a safety control. It limits the temperature so that the ducts will not be subjected to excessive heat. The high-limit sensor is installed in the conditioned air supply duct downstream of the anticipator sensor.

Signal inputs from the temperature selector rheostat and compartment temperature sensor are compared in the control box. If selected temperature and actual temperature are not the same, an error signal is generated to produce the appropriate "more heat" or "less heat" output signal to the temperature control valve.

This is a pulsed output, in which the length of the pulses is proportional to the temperature difference. A large difference in temperature produces longer pulses, and a small temperature difference results in shorter pulses.

The duct anticipator function differs from that of the compartment temperature sensor and high-limit sensor in that while the other two sensors are concerned with the temperature itself, the duct anticipator provides input for comparing temperature change. Its purpose is to control the rate at which changes in temperature take place.

As the temperature control valve drives in response to a demand for an increase or decrease in heating or cooling, the duct temperature begins to change. This change is detected by the duct anticipator, which causes a signal to be developed in the control box opposing the temperature difference error signal.

The result is to inhibit the valve driving signal. As duct temperature stabilizes, the anticipator circuit is satisfied and the temperature change signal is removed. If the compartment temperature has not reached the desired level by then, an error condition still exists and the temperature control valve will begin to drive again.

This operation continues until actual and selected temperature are equal. The selected temperature is thus approached gradually, which helps prevent overshooting. Because of this action, it takes a few minutes for cabin temperature to stabilize when the system is first turned on or when the temperature selection is changed.

Whenever the selected temperature is considerably higher than actual temperature (15 degrees or more), the temperature control valve could drive fully open long before the large volume of interior air is heated to the desired temperature, resulting in excessively high duct temperatures. The high-limit sensor protects the distribution ducting in this situation by producing a signal in the control box that will remove the more heat signal to the valve and apply the less heat signal.

When the duct temperature drops about 20 to 30 degrees, the high-limit circuit resets and normal control is in effect again. The system can cycle on this high limit until the interior temperature has risen to about the desired level and normal control can cause the temperature control valve to cut back.

The high-limit circuit is also designed to protect the system from a faulty sensor. If the sensor becomes either open or shorted, the temperature control valve will be driven closed.

Manual Temperature Control

Manual operation for more heat is accomplished by toggling the temperature control switch to WARM. The manual more heat drive signal goes through the control

Left: Air conditioning controls, flight station overhead control panel. Left, below: Cargo compartment temperature sensor. Below: Underwing area, right side.



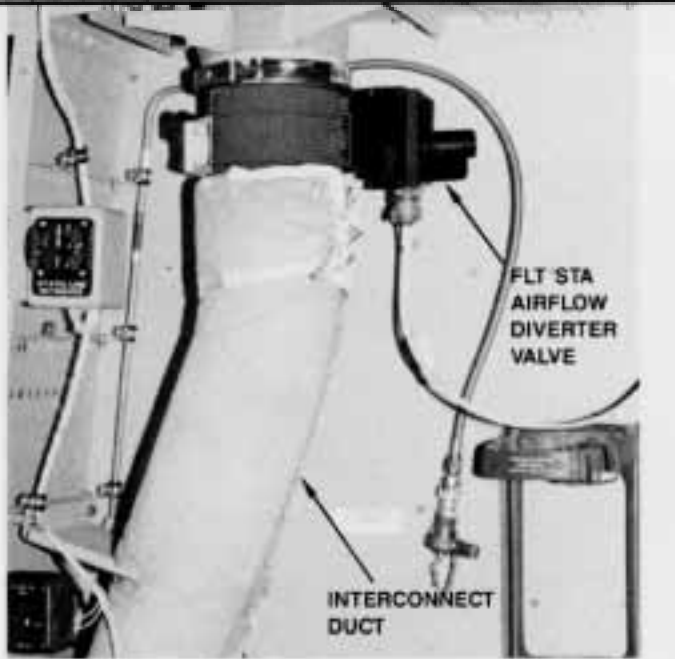

Aft side of FS 245 bulkhead, on right.

box for two reasons; first, the output signal is pulsed to prevent a too-rapid rise in duct temperature, and second, to take advantage of the duct high-limit protection circuit. Even though the valve is driven open in pulses, the driving time is somewhat faster than in AUTO because the duct anticipator circuit has no effect during manual control.

When the temperature control switch is positioned to COOL, power is applied directly to the valve to drive it toward closed. The valve will drive continuously (no pulsing) until it reaches the fully closed position or until the switch is released.

Air Conditioning Systems Interconnect

The conditioned air supply ducts from the cargo compartment system and flight station system are connected by an interconnect duct. If either system is not operating, conditioned air can be supplied from the operating system to the other compartment.

A four-position valve in this duct controls the distribution of air between the two systems. The valve is controlled by the flight station airflow switch (labeled FLT STA AIRFLOW) on the air conditioning control panel. The switch positions indicate how much of the conditioned air from the flight station unit will be ducted to the flight station, with the remainder going to the cargo compartment.

In the MIN position, only about 30% of the air from the flight station unit will go to the flight station. In the NORMAL position, about 60% will go to the flight station, in INTMED about 80%, and in MAX, all the air from the flight station unit will go to the flight station.

With both systems operating, normal airflow is from the flight station system to the cargo compartment. Therefore, if the cargo compartment system is shut down, air will continue to flow to the cargo compartment from the flight

station system unless the FLT STA AIRFLOW switch is positioned to MAX.

Note that if the flight station system has to be shut down for some reason, it may be necessary to turn on the cargo compartment air recirculation fan (or floor heat) in order to get any appreciable airflow to the flight station. This creates a back pressure in the duct, which is necessary to force air to flow up to the flight station.

Also, the flight station airflow switch should be positioned to MIN to fully open the interconnect valve. Incidentally, this valve is powered by 115 volts AC from the essential AC bus. It is the only environmental systems control valve that does not operate on 28 volts DC.

Floor Heat System

The floor heat system provides additional heat in the cargo compartment floor area when needed. It is an independent system which can be used in conjunction with or independently of the air conditioning systems. The system is controlled by the UNDERFLOOR HEATING switch on the air conditioning control panel.

Figure 3

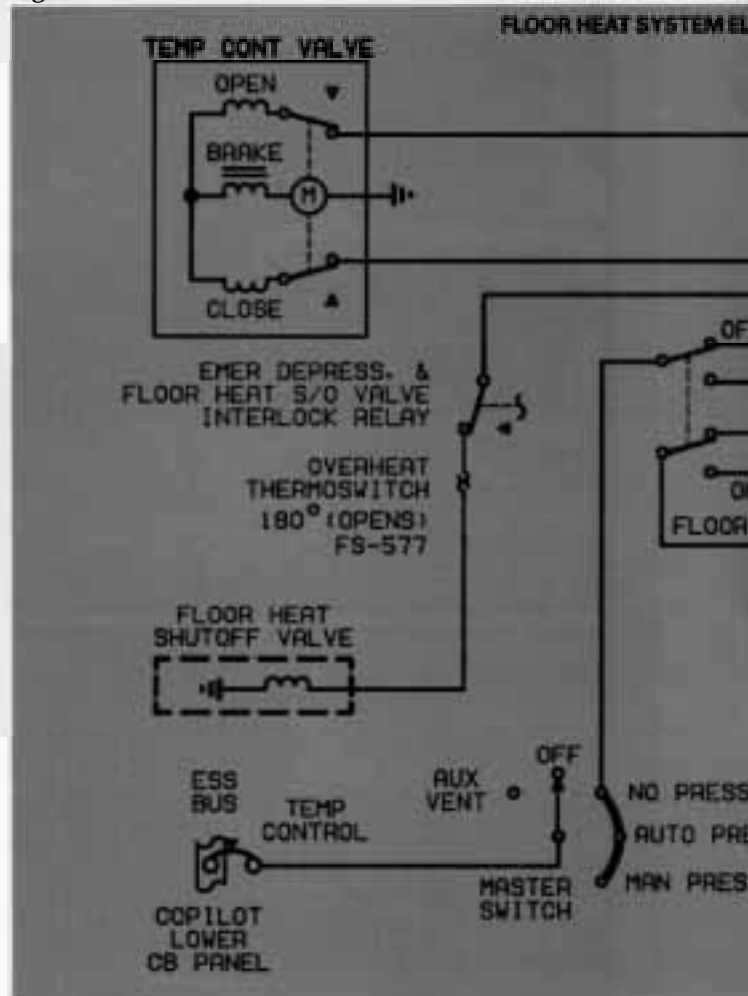

Two valves control floor heating, a solenoid-controlled, air-operated shutoff valve and a motor-driven temperature control valve. The valves are located in the upper right wheel well area next to the cargo compartment flow control and shutoff valve.

Underfloor heating is accomplished by mixing bleed air with ambient underfloor air and piping the mixture through forward and aft distribution ducts. The amount of bleed air supplied is regulated by the floor heat temperature control valve.

Temperature control is completely automatic. The valve is operated by a temperature sensing and control unit which is mounted next to the ejector assembly under the center floor panel between the wheel wells at fuselage station 497. This unit senses the temperature of the underfloor air being drawn into the ejector, and operates the temperature control valve to continuously supply the amount of bleed air required to maintain a temperature of approximately 75 degrees F.

Figure 3 shows the electrical control circuit for the floor heat system. When the air conditioning master switch is

placed in an "on" position (NO PRESS, AUTO PRESS, or MAN PRESS) and the floor heat switch is positioned to ON, power is supplied to the control unit and to the shutoff valve.

The shutoff valve is energized and air-actuated open. The control unit senses underfloor temperature and provides as appropriate more heat and less heat outputs to drive the temperature control valve.

When the system is turned on, power is supplied to energize a relay which then supplies 3-phase power to operate the cargo compartment air recirculation fan. Fan power is supplied from the LH AC bus. This requires the use of ground power or at least two engine generators. When the system is turned off, the fan can be operated by a separate FAN switch located next to the floor heat switch on the air conditioning control panel.

An overheat thermostat is installed next to the aft distribution duct at fuselage station 577. It is located so as to sense the temperature of the air coming out of the distribution duct at that point.

If a malfunction of the control system occurs such that this air temperature reaches 180 degrees F, the thermostat actuates to remove power from the shutoff valve, causing it to close. Since the thermostat will automatically reset when the temperature drops about 20-30 degrees, the system will cycle on and off unless turned off by the floor heat switch.

Since floor heating is a separate system, it is necessary to provide a means of shutting off the system in the event of an emergency. This is accomplished by a relay which is

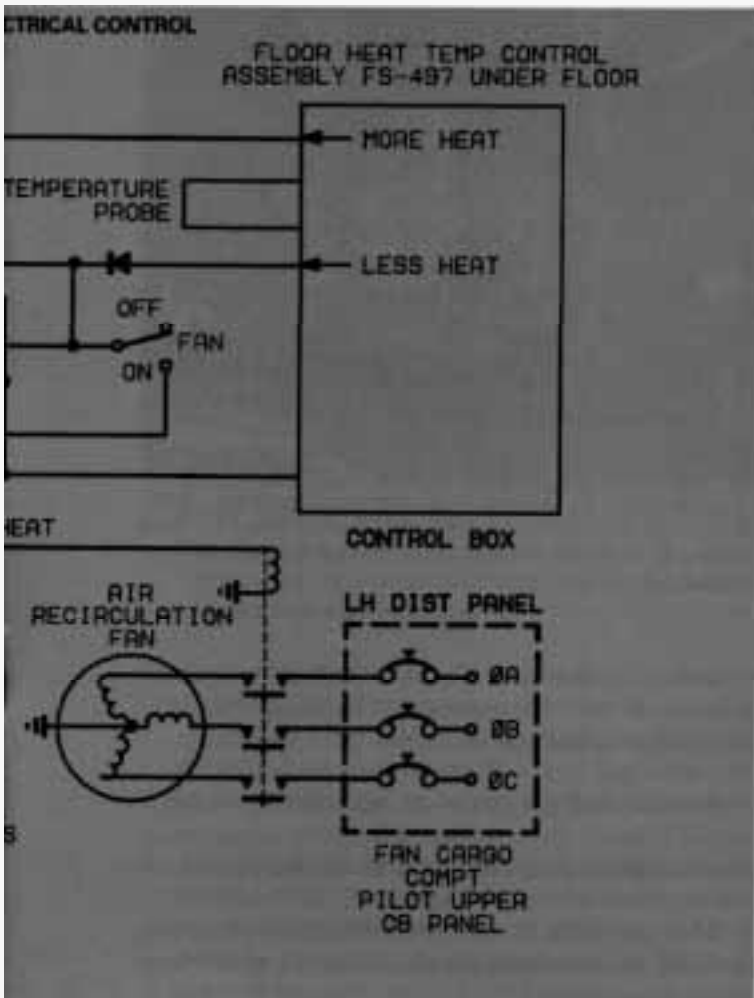

Floor heat thermostat and control box.



Bimetallic thermostat



controlled by the EMERGENCY DEPRESSURIZATION switch on the air conditioning control panel. When the depressurization switch is actuated, the relay is energized to remove power from the floor heat shutoff valve, causing it to close.

TROUBLESHOOTING THE SYSTEM

As with most aircraft systems, it is not always easy to pinpoint the source of a problem in the Hercules air conditioning system immediately. It generally requires systematic troubleshooting, and often the best question is where to begin.

There are several troubleshooting approaches that a technician may utilize to correct problems in a discrepant air conditioning system. These range anywhere from checking system circuits and operation with an advanced system tester such as the Lockheed PN 3402247-1 Temperature Control Analyzer, to replacing one component at a time in a process of elimination.

It is unfortunately not possible to offer a new procedure that will solve all air conditioning ills in a few minutes, nor should you abandon your present troubleshooting method if it is getting the job done in a reasonably efficient manner. What we would like to offer here, however, are some ideas and suggestions which you may find helpful in improving your own troubleshooting technique.

Trouble reports written against the air conditioning system in the Hercules aircraft usually fall into one of two categories. Either the system won't cool (or heat) properly, or the temperature is reported to be fluctuating excessively. Also, occasionally a problem with the airflow from the cargo compartment (or flight station) system may be reported.

If the Temperature Control Analyzer is not available, a good troubleshooting approach to use also happens to be a very basic one. Start by isolating one component in the system and then, if that component proves satisfactory, add another component and then another in a logical sequence until the entire system has been covered or the faulty component found and replaced.

In cases where you have a good idea of the cause of the trouble, it won't be necessary to run the complete check; the final proof, however, must be that the system works properly after the suspected component has been replaced.

Note particularly the following:

- You will need a volt-ohm-milliammeter (VOM) to troubleshoot this system.
- In the steps below, the phrase "turn the master switch on" means place the air conditioning master switch in the *NO PRESS* position.

- It is assumed in the following procedure that the circuit wiring is good. If you have replaced the suspected faulty component indicated in the procedure and the trouble still exists, check the circuit wiring.

System Airflow Check

Connect ground power and operate the APU for the air supply. Make sure the compartment air conditioning switch, emergency depressurization switch, and temperature selector rheostat are in *NORMAL*. Turn the master switch on and place the temperature control switch in *AUTO*. The airflow from the ducts should be almost strong enough to force your hand away.

If flow is weak, or if there is no flow, check the position of the flow control valve. The position indicator on the side of the valve should indicate about one-third to one-half open. The valve operation is affected by ambient conditions and bleed air system pressure; therefore the exact position may vary somewhat, depending on operating conditions.

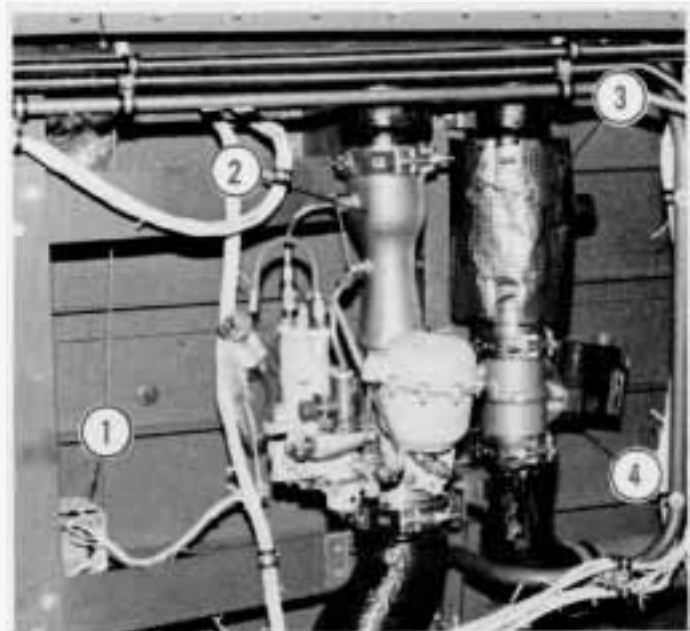

Cargo compartment air conditioning system components, upper right wheel well area: (1) Air conditioning shutoff relay. (2) Flow control valve. (3) Floor heat shutoff valve. (4) Floor heat temperature control valve.

Be sure to check for system leakage at duct joints, especially at the water separator. Visual inspection will usually pinpoint this type of trouble.

A failed cooling turbine will also result in reduced airflow; however, this condition will also be accompanied by an inability of the system to provide adequate cooling.

When you finish the airflow check you can shut down the APU. It isn't needed to accomplish the *temperature control system check*.

Low-Limit System Check

A malfunction of the low-limit system can cause temperature control problems. If the system fails in the “hot” condition, the temperature control system will not be able to provide sufficient cooling. If the low-limit system fails in the “cold” condition, the water separator may ice up. This condition can result in reduced airflow or a system shutdown. The reduced airflow may be accompanied by ice crystals coming out of the conditioned air outlets.

A faulty low-limit temperature sensor can produce either of the conditions mentioned above. A shorted sensor will cause the valve to drive fully open; an open sensor will cause the valve to drive fully closed. You can check the sensor with a VOM. The resistance should be 220 ± 4 ohms at 75 degrees F. Add 3 ohms for each 5 degrees above 75 degrees and subtract 3 ohms for each 5 degrees below 75.

- 1 To begin the system checkout, turn the master switch to OFF and check the position of the low-limit valve. It should be fully open. If the valve is fully open, proceed with the next step.

If it is not, turn the master switch on and disconnect the electrical connector from the valve. Turn the master switch to OFF and check for 28 volts DC on pin A (more heat) of the circuit connector. If the voltage is present, replace the valve. If the voltage is not present, replace the low-limit relay.

- 2 This step checks the less heat drive. Turn the master switch on and pull the CABIN PRESS & AUX VENT circuit breaker. Pulling this circuit breaker prevents the valve from driving full open every time the master switch is turned to the OFF position.

If the ambient temperature is above 40 degrees F, the low-limit valve should begin pulsing toward closed (less heat). If it does this, go to Step 4. If it does not, turn the master switch to OFF and disconnect the electrical connector from the valve. Turn the master switch back on and check for pulsing 28 volts at pin B of the circuit connector. If the voltage is present, replace the valve; if not, proceed with the next step.

- 3 Turn the master switch to OFE reconnect the valve, and disconnect the electrical connector from the low-limit sensor. Turn the master switch back on. The valve should pulse toward closed. If it does this, replace the sensor; if it does not, replace the low-limit control box.
- 4 This step checks the more heat drive. Turn the master switch to OFF Disconnect the electrical connector from the low-limit sensor and remove the sensor from the duct. Reconnect the electrical connector to the sensor and turn the master switch back on.

Allow the valve to drive toward closed so that it is not fully open, then dunk the sensor in a cup of ice water. The valve should begin to pulse toward open. If it does not, turn the master switch to OFF, disconnect the electrical connector from the sensor, jumper pins A and B in the circuit connector, and turn the master switch back on. If the valve still does not drive, replace the control box; if it does, replace the sensor.

Remember to reset the CABIN PRESS & AUX VENT circuit breaker when you are done.

One final point. If air conditioning system shutdown was experienced and the low-limit system tests out OK, check the water separator pressure switch. A continuity check across pins A and B of the switch should show an open circuit. If not, the switch is bad.

Temperature Control Problems-General Hints

A “too hot” or “too cold” problem usually falls into one of two categories:

- The system works in manual but not in auto.
- The system will not work in either auto or manual.

If the system works in manual but not in auto, suspect those components which provide automatic control, in other words, the sensors and the control box.

If the system does not work in either automatic or manual control, the most likely suspect is the temperature control valve. However, do not rule out the possibility of a bad control box, since the control box supplies the power to the temperature control switch.

Checking Temperature Sensors

Bad temperature sensors can cause “too hot” (system won’t cool), “too cold” (system won’t heat), and “excessive fluctuation” complaints. The compartment sensor, duct anticipator sensor, and high-limit sensor can all be checked for proper resistance the same as the low-limit sensor. The pins to check on the sensors are:

- Cargo compartment temperature sensor B-C
- Cargo compartment duct anticipator sensor C-D
- Cargo compartment duct high-limit sensor A-C
- Flight station compartment temperature sensor B-C
- Flight station duct anticipator sensor A-B
- Flight station overheat sensor A-B

The resistance of all these sensors should be 220 ± 4 ohms at 75 degrees F, plus 3 ohms for each 5 degrees over 75, minus 3 ohms for each 5 degrees below 75.

Temperature Fluctuation Problems

The system should be able to maintain the selected temperature within plus or minus two degrees at the compartment sensor. Excessive fluctuation (hunting) can be caused by the following:

- A dirty compartment temperature sensor.
- An inoperative blower motor.
- A bad duct anticipator sensor.
- A bad temperature control box.

Clean the compartment temperature sensor and ensure that the blower is operating (master switch on). If temperature still fluctuates excessively, check the resistance of the duct anticipator sensor. If this unit checks good, replace the control box.

Troubleshooting “Too Hot” Problems

The items that can cause a “too hot” condition are:

- A temperature control valve failed in the open position.
- A shorted compartment temperature sensor.
- A bad temperature control box.

Note: If the system works in manual but not in auto, use manual control to make sure the valve is not fully closed and skip to step 2.

1. To check the valve, turn the master switch on and hold the temperature control switch in the COOL position. The valve should drive continuously toward closed (no pulsing). If it does, go to the next step.

If not, turn the master switch to OFF and disconnect the electrical connector from the valve. Turn the master switch on, hold the temperature control switch in COOL, and check for 28 volts at pin B of the circuit connector. If the voltage is present, replace the valve; if not, check terminal 4 (center terminal) of the temperature control switch. If the voltage is not present here, replace the temperature control box.

2. Turn the master switch to OFF and disconnect the electrical connector from the compartment sensor. Turn the master switch back on and place the temperature control switch in AUTO. The valve should start pulsing toward closed. If it does, replace the sensor; if not, replace the control box.

Troubleshooting “Too Cold” Problems

The items that can cause “too cold” problems are:

- A temperature control valve failed in the closed position.

- An open compartment temperature sensor.
- A bad temperature control box.
- An open or shorted high-limit temperature sensor.

Note: If the system works in manual but not in auto, use manual control to make sure the temperature control valve is not fully closed and skip to step 3.

1. To check the valve, turn the master switch to OFF and disconnect the electrical connector from the valve. Jumper pin B of the circuit connector to pin A of the valve and pin C of the circuit connector to pin C of the valve (you are connecting the less heat command line to the more heat side of the valve). Turn the master switch on and hold the temperature control switch in COOL. The valve should drive continuously toward open. If it does not, replace the valve.
2. Use a VOM to check for an open or shorted high-limit sensor. Check pins A-B on the flight station sensor or pins A-C on the cargo compartment sensor. The resistance should be as given earlier in this article.
3. Turn the master switch to OFF and disconnect the electrical connector from the compartment sensor. Jumper pins B and C in the circuit connector. Turn the master switch back on and place the temperature control switch in AUTO. The valve should pulse toward more heat. If it does, replace the sensor; if not, replace the control box.

When you have finished, be sure to reconnect and appropriately safety-wire all electrical connections.

A properly functioning air conditioning system is not just a matter of comfort in a modern aircraft. It is also vital to the safe and effective operation of the cabin pressurization system, a system which makes efficient high-altitude flight a practical reality.

Fortunately, the air conditioning system of the Hercules aircraft, with its proven reliability, high capacity, and built-in redundancy, can be relied upon to turn in a top performance day after day with relatively little attention. When service is required, however, the information provided above should help you get your Hercules airlifter back on the job in the shortest possible time.

Service News wishes to thank C. E. Madison for his invaluable assistance in the preparation of this article.



Firewall Shutoff Valves

PREVENTING SHUTOFF VALVE THERMAL EXPANSION DAMAGE

by Bill Simpson, Staff Engineer
Project Engineering Hydraulics Group

Valve motor burnout or valve housing damage in engine-driven hydraulic pump suction line shutoff valves is sometimes blamed on internal limit switch misadjustment or failure.

Although at first glance the valve housing and housing end plate may appear to have been damaged by over-driving of the valve gate mechanism, further investigation usually reveals that excessive hydraulic pressure distorted the housing and jammed the gate, which in turn caused the motor to burn out.

The excessive pressure is caused by thermal expansion of hydraulic fluid trapped in the suction line, a factor which can have serious consequences during wide swings in the ambient temperature. The reason why the fluid becomes trapped can usually be traced to failure to follow through with the procedures described in paragraphs 3-23 through 3-25 of T.O. C-130H-2-3.

When an engine or an engine-driven hydraulic pump is removed from the airplane, and the hydraulic lines are disconnected at the firewall quick disconnects or at the pump, the maintenance manual directs that a 3/8-inch jumper hose be installed to connect the case drain and suction lines to prevent loss of fluid or contamination of the system.

Once the jumper hose has been installed, it is important that proper attention be paid to the position of the motor-operated firewall shutoff valve and pump shutoff valve of the removed engine.

If the remaining engines are to be operated on an aircraft with the jumper hose installed, the suction boost pump of the system being operated should be turned on, but both the suction line shutoff valve and the pump shutoff valve of the removed engine must be shut off.

This prevents the hydraulic fluid from being heated excessively by the high rate of flow which would result from boost pump pressure being continuously dumped to return

through the open valves in the empty nacelle. These valves must not, however, be left in the closed position after the engine run has been completed and suction boost pump has been shut down.

When the case drain and suction lines are connected by a jumper hose, the motor-operated firewall shutoff valve and pump shutoff valve should be left in the open position under all circumstances other than during an engine run. This will protect the motor-operated shutoff valve from possible damage by preventing a buildup of pressure in the jumper hose during rapid changes in the ambient temperature.

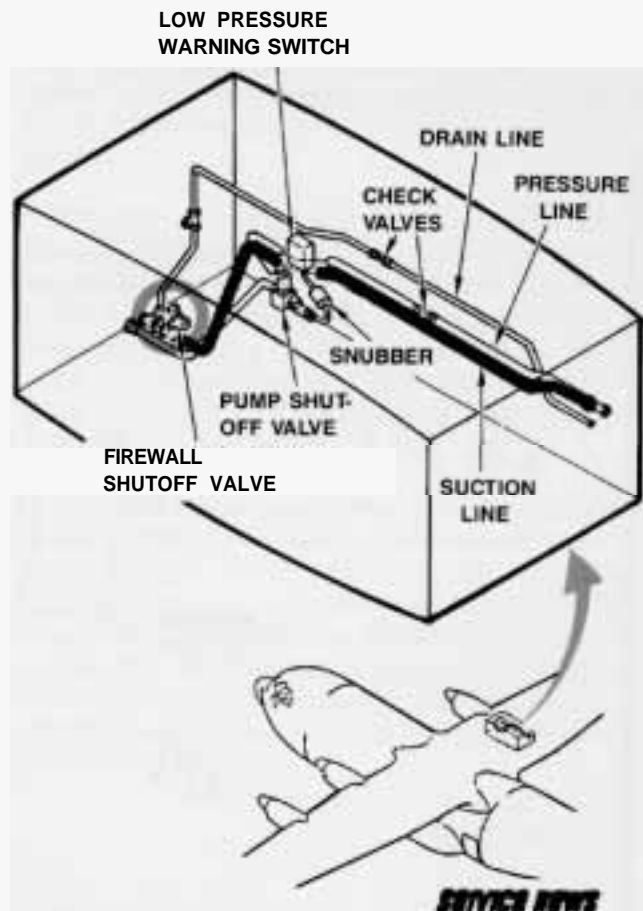

Engine Rear Bearing Support and Tailpipe Failures

by **Darel Traylor**, *Service Analyst Coordinator*
C-130/Hercules Field Service Department

Lockheed has recently received a number of reports describing cracking of the engine turbine rear bearing support or tailpipe. In many cases there has been no clear indication as to the cause of the trouble or evidence of associated problems. Experience has shown that failures of this type can usually be traced to one or more of the following conditions:

- Improper installation of the tailpipe clamp assembly.
- Excessive turbine vibration.
- Turbine vane-to-spacer rubbing.

Cracking caused by improper installation of the tailpipe clamp assembly will not normally be accompanied by any other failures or symptoms of trouble. The best way to avoid problems of this type is to carefully follow the explicit instructions for installation and torquing of the tailpipe assembly that are found in the final chapter of the appropriate Engine Power Package Build-up Instructions (-10) for your aircraft.

Excessive turbine vibration will usually cause cracking of other components besides the turbine rear bearing support or tailpipe. Inspect such items as sheet metal mounting brackets in the QEC, the TD valve mounting brackets, external oil tube mounting brackets, and so forth. Damage to these parts as well is an indication that excessive turbine vibration is present.

Turbine vane-to-spacer rub will also cause vibration that can result in turbine rear bearing support or tailpipe failure. One of the tell-tale signs of turbine rub is the presence of ferrous metal dust or granular material in the bottom of the turbine bearing support. If turbine rub is suspected, the problem should be investigated in accordance with Allison document T56-A-15/LFE CSL 1531 to determine the serviceability of the engine.

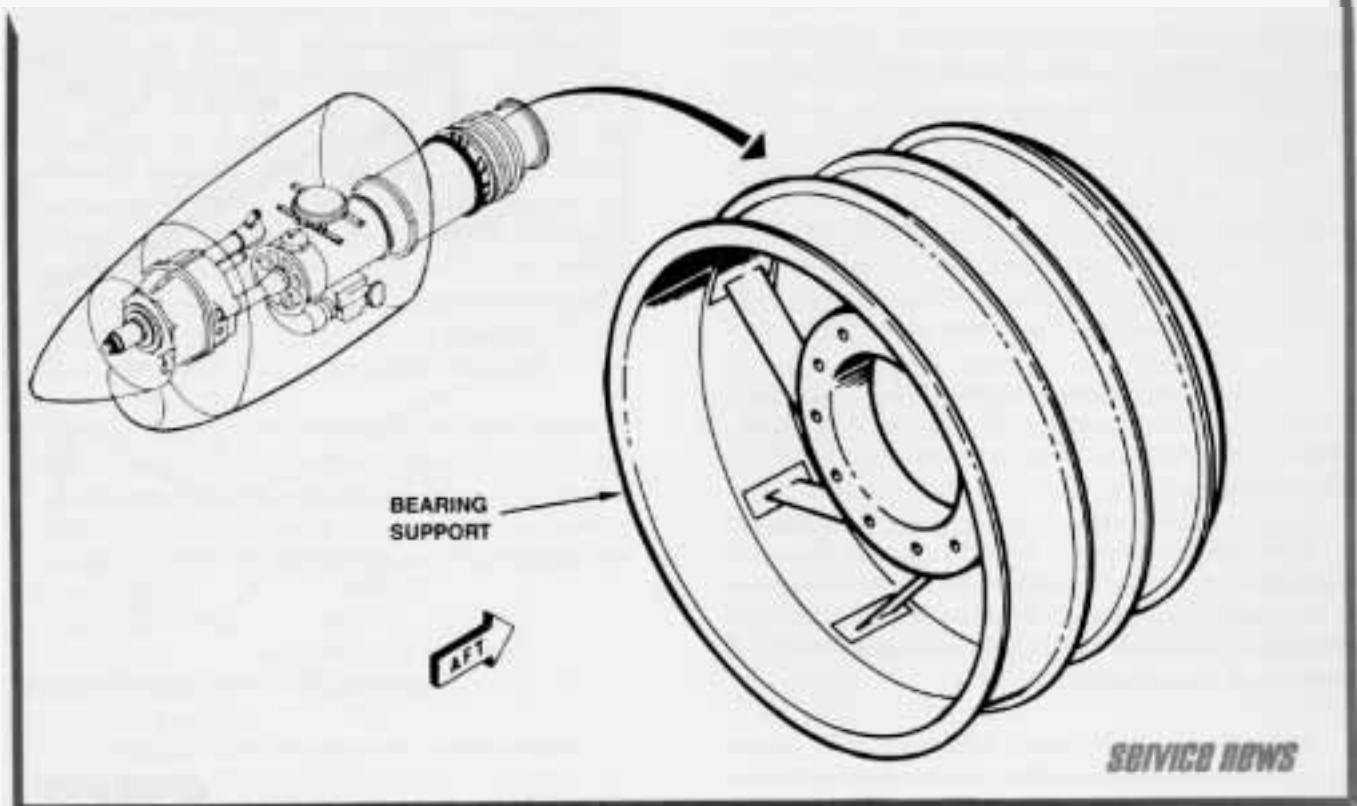

RAAF WINS TOP HONORS in 1989 Airlift Rodeo

The Royal Australian Air Force's No. 36 Squadron was the big winner at the 1989 Airlift Rodeo competition, held during the week of June 5th at Pope Air Force Base in North Carolina. More than 1,600 airlift professionals competed in a week of intense flying, even though the weather was often unfavorable. Thunderstorms and low ceilings made operations difficult and disrupted flying schedules on some days. Forty teams from around the world competed in the event, including Australia, Canada, France, West Germany, Israel, Japan, and the United States.

No. 36 Squadron not only won the trophies for best C-130 crew and best foreign crew, but the unit was also the prime contributor to Australia's biggest ever win as "Best Overall Wing." It is only the fourth time in the Rodeo's ten-year history that a team from outside the U.S. has captured the top title.

The RAAF's No. 36 Squadron, currently based in Richmond, New South Wales, was originally formed in March 1942 with DC-2 aircraft at Laverton, near Melbourne in Victoria. During World War II, it operated in the southwest Pacific theater as transport support squadron, principally in and around New Guinea. After the war, the squadron



was based in several different areas around Australia, and even spent two years operating out of Japan. In 1958, the 36th was relocated to its present home at Richmond, near Sydney in New South Wales.

The 36th squadron was equipped with its first Hercules aircraft, the C-130A, in 1958. Australia was the first nation after the U.S. to make use of the C-130 Hercules. The RAAF accumulated 148,061 accident-free flying hours with the C-130As before these aircraft were replaced with C-130Hs in 1978. Since then, the C-130H aircraft have flown in excess of 90,000 accident-free hours.

The RAAF also operates the C-130E, which is flown by No. 37 Squadron, also based at Richmond. Between No. 36 and No. 37 Squadrons, the RAAF has accumulated over 448,000 accident-free hours using three different models of the Hercules aircraft. No. 36 Squadron is presently looking forward to its 50th anniversary in 1992, which should also be the same year it will achieve 100,000 flying hours in the C-130H.



SERVICE NEWS



Training Systems Department
LASC-Georgia
Marietta, GA 30063



Congratulations, Australia!