

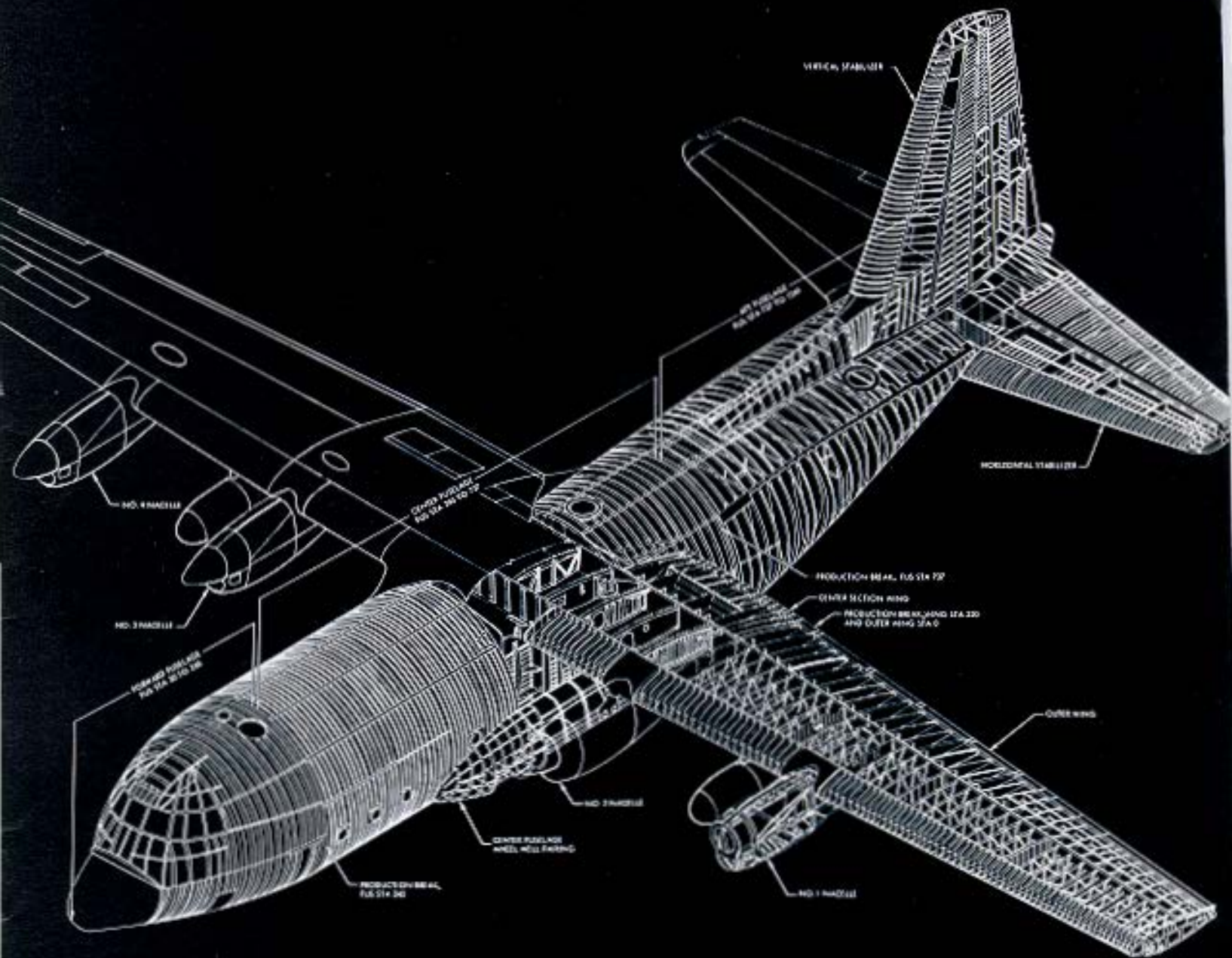

SERVICE NEWS

A SERVICE PUBLICATION OF LOCKHEED-GEORGIA COMPANY, A DIVISION OF LOCKHEED AIRCRAFT CORPORATION





SERVICE NEWS

A SERVICE PUBLICATION OF
 LOCKHEED-GEORGIA COMPANY
 A DIVISION OF
 LOCKHEED AIRCRAFT CORPORATION

Editor
 Jay V. Roy

Associate Editors
 Don H. Hungate
 James A. Loftin

Art Direction & Production
 Anne G. Anderson

VOL. 4, NO. 2, April - June 1977
CONTENTS

- 3 Leaky Fasteners**
 - 5 Description of Fastener Systems
 - 6 Chart - History of Fasteners Used in Hercules Integral Wing Tanks
 - 12 Leak Detection and Repair

- 15 Repair of Rubber Covering on Inflight Refueling Hoses**

- 15 New Check Valve**
 - Specified for Hercules Hydraulic Pump Pressure Lines

- 14 StarTips**
 - Installation Tool - Wing Leading Edge Hinge Pin

Front Cover: Inside the Hercules - this months cover depicts a simplified cutaway of the Hercules, representative of the C-1 30H configuration.

Published by Lockheed-Georgia Company, a Division of Lockheed Aircraft Corporation. Information contained in this issue is considered by Lockheed-Georgia Company to be accurate and authoritative; it should not be assumed, however, that this material has received approval from any governmental agency or military service unless it is specifically noted. This publication is for planning and information purposes only, and it is not to be construed as authority for making changes on aircraft or equipment, or as superseding any established operational or maintenance procedures or policies. The following marks are registered and owned by Lockheed Aircraft Corporation: "Service News", "Lockheed", "Hercules", and "JetStar". Written permission must be obtained from Lockheed-Georgia Company before republishing any material in this periodical. Address all communications to Editor, Service News, Department 64-22, Zone 278, Lockheed-Georgia Company, Marietta, Georgia 30063. Copyright 1977 Lockheed Aircraft Corporation.

SERVICE is our Business



We reinstated the Service News magazine in January 1973 as part of our total product support program objective to bring you, our customers, the best service possible.

As we enter our fourth year of publication, we wish to thank our readers around the world for the fine reception you have given the magazine.

We also wish to welcome the new readers we have acquired with the introduction of the JetStar II and the ever expanding family of Hercules customers.

As we stated in the first issue, this is your magazine. So we welcome your suggestions, tips, or criticisms on how we can make the Service News more useful to better serve you. Just pass your comments to your Lockheed-Georgia Company Field Service Representative or send them to the Editor (address given on lower left corner of this page).

Below are the leaders of our product support team who stand ready to help you with any problem you may have concerning the Hercules or JetStar. Just let them know if you need assistance.

T. J. CLELAND

Director of PRODUCT SUPPORT

Customer Service Division



D. L. BRAUND, MGR

Customer Supply Division



M. M. HODNETT, MGR



H. L. BURNETTE, MGR
 JetStar Support Dept



A. H. McCRUM, MGR
 Field Service & Inventory Management Dept



C. K. ALLEN, MGR
 Supply Systems & Inventory Control Dept



H. T. NISSLEY, JR., MGR
 Supply Sales & Contracts Dept



E. L. PARKER, MGR
 Customer Training Dept



J. K. PIERCE, MGR
 Spares Stores & Shipping Dept



J. L. THURMOND, MGR
 Supply Technical Support Dept



R. C. WEIHE, MGR
 SUPPLY Procurement Dept

Leaky Fasteners

by M. G. Billias, *Development Engineer Specialist*
M. V. Cobb, Jr., *Design Engineer, Senior*
F. D. Poss, *Components Engineer, Senior*

The development and use of the aircraft integral fuel tank has resulted in problems along with the many advantages of the system. One of the more chronic problems is that of fuel tank leaks; and, as with any other aircraft, the Hercules is susceptible to such leaks. A major cause of fuel tank leaks is the fasteners.

This article provides general information on how to detect and eliminate existing fastener leaks, and how to minimize future fastener leaks. Items covered are: The various Hercules tank configurations, purpose of fasteners, a description of five different fastener systems, installation and removal techniques, use of oversized fasteners, leak detection and repair, and testing.

A BRIEF HISTORY

The Hercules has gone through several model changes over the years; and, although the outward appearance of the airplane is the same, many aspects of the airplane have been greatly improved. This includes the sealing of the integral fuel tanks and the introduction of improved fastener systems.

The original "A" series aircraft integral fuel tanks were not sealed in the faying surfaces; sealing was limited to

post-assembly sealed fillets and brush coats. This sealing procedure caused extreme difficulties in locating a true leak source since leaks could "channel" along a seam. The original sealant used was a polysulfide type conforming to MIL-S-7502. This was topcoated with MILS-4383 Buna N. These were the best materials available at that time.

Faying-surface sealing was not used on earlier model aircraft due to a belief that applying an elastic sealant in the faying surfaces was structurally unacceptable and would result in excessive flexing of the wing. It has since been proven that faying-surface sealing, properly accomplished, does not degrade the structure and offers a big advantage to fuel tank sealing as well as to corrosion control.

Lockheed has always used the latest state-of-the-art materials for sealing and coating the fuel tanks; and, as a result, various sealing and coating materials can be found in the fuel tanks. A summary of the materials used in the manufacture of the Hercules is listed in Figure 1. It should be realized that the original materials used in sealing and coating the tanks may no longer be in service. Certain older aircraft that have undergone numerous modifications or update programs will probably contain the latest coatings and sealants.



LOCKHEED A/C NO.	TANK COATING	FAY SEALANT	POST- ASSEMBLY SEALANT	TOP- COAT
3001/3122	Buna-N		MI LS-7502	Buna-N
312313164	Buna-N		MI L-S-8802	Buna-N
316513231	Spray Polysulfide/ Bona-N		MI L-S-8802	Buna-N
(323213500 Not Assigned)				
350113882	Spray Polysulfide/ Buna-N	Polysulfide Film	MI L-S-8802	Buna-N
388314126	Polyurethane MI L-C-27725	Polysulfide Film	MI L-S-8802	
4127/4313	Polyurethane MI L-C-27725	Polysulfide LAC 40-105	MI L-S-8802	-
431414330	Polyurethane MI L-C-27725 w/biocidal dye	Polysulfide LAC 40-105	MI L-S-8802	MIL-C- 83019
4331 & up	Polyurethane MI LX-27725 w/biocidal dye	Inhibited Polysulfide STM 40-111, STM 40-112 (MIL-S-81733)	MI L-S-8802	MI L-C- 83019

Figure 1 SUMMARY OF SEALING MATERIALS

CURRENT SEALING METHODS

- 4 The current production aircraft are processed and sealed as follows:
1. Prior to wing buildup, all detail parts forming the fuel tank structure are coated with MIL-C-27725 polyurethane. The major structural components forming the lower surface of the fuel tanks (skins, beam caps, etc.) are given a second coat of MIL-C-27725 containing a biocidal color additive (green) immediately after application of the first coat.
 2. All detail parts forming the fuel tank boundary are faying-surface sealed with MIL-S-81733, types II or IV, corrosion inhibiting sealant.
 3. All fasteners penetrating the fuel tank boundary are wet-installed with MIL-S-81733, types II or IV, corrosion inhibiting sealant.
 4. All joints in the fuel tank boundary are fillet sealed with MIL-S-8802, Class B sealant.
 5. All fasteners penetrating fuel tank boundaries are brush overcoated with two coats of MIL-S-8802, Class A sealant.
 6. All sealant in the fuel tank is top-coated with MIL-C-83019 clear polyurethane.

HERCULES INTEGRAL FUEL TANKS

The following general description of the Hercules integral fuel tanks is applicable to all series and versions of Hercules airplanes. Configuration of individual components of the outer wing varies from airplane to airplane due to the numerous series and versions produced; the many product improvement changes incorporated during the aircraft's production history; and modifications made during the operational life of the airplane.

The Hercules has four separate integral tanks; two in the left outer wing and two in the right outer wing. The tanks are separated by a dry bay compartment located immediately behind the number 1 and the number 4 engines. The boundaries of each integral tank are the outer wing upper and lower surfaces; the front and rear beams; and inboard and outboard bulkheads.

The outer wing upper and lower surfaces each consist of four, integrally-stiffened, machined skin panels; caps for the wing box ribs; and a wing joint (rainbow) fitting. Front and rear beams consist of machined beam caps, webs, and vertical stiffeners attached with mechanical fasteners. Integral tank bulkheads consist of integrally stiffened webs attached to upper and lower caps - except for the outer wing station 0 bulkhead, where the bulkhead web is attached to the upper and lower rainbow fittings. Ribs inside the outer wing box structure are truss-type ribs with the truss members bridged between the upper and lower surfaces rib caps. The majority of the rib caps are attached to the integral stiffeners of the skin panels with rib cap clips. All of the tank bulkhead caps attach to the skin portion of the integrally stiffened panels. Figure 2 illustrates these tank configurations.

FASTENERS USED ON THE HERCULES

The primary purpose of all fastener systems is to hold the structure together. A secondary purpose is to prevent premature structural fatigue failures in the structure around, or at, the fastener holes. A third purpose, or function, of fasteners in fuel tanks is to seal the fastener holes from fuel leaks.

Generally, the priorities of the above purposes are in the order listed; however, in individual instances and in the daily performance of missions, these priorities change. For example, it is possible to have a defective fastener or even a missing fastener and the airplane still be structurally sound to accomplish its mission; but, if there is fuel leaking from this defective fastener location, or if fuel is pouring from the hole which is created by the missing fastener, then the airplane is unsafe for flight. The third purpose and priority now becomes the primary purpose and priority for fasteners.

Fastener systems used in the Hercules wings are:

Taper-Lok with Washernut

- NASI724-()-()/TL100-()-() – Flush head pin
- NASI728-()-()/TL200-()-() – Protruding head pin

Huckrimp with Krimpnut

- NAS4466-()-()/KS200DT-()-() – Flush head pin
- NAS4458-()-()/KSPDT-()-() – Protruding head pin
- NAS4445()/OKNE-() – Collar (Krimpnut)

Hi-Lok with Collar or Washernut

- HL19PB()-() – Flush head pin
- HL1 8PB()-() – Protruding head pin
- HL70-() – Collar

Lockbolt with Swaged Collar

- NAS14()H() – Pin
- NAS70()H() – Pin
- NAS1080-() – Collar

Screw

- NASS 17-()-() – Screw
- MS21042-() – Hex Nut

Fasteners used in the various joints of the outer wing are shown in Figure 3. The table is specifically oriented to the Hercules, LAC Serial No. 3501 and up; however, it will apply, in many instances, to other series of the Hercules.

NOTE: The reader is cautioned that the fastener usage chart is general in nature and exceptions may exist in all areas.

DESCRIPTION OF FASTENER SYSTEMS

Taper-Lok with Washernut

The Taper-Lok pin is an alloy steel (108 ksi shear) pin having a taper of 1/4 inch per 12 inches. The pin is pulled into an interference fit tapered hole with a steel Washernut. See Figure 4.

This system is used in the most fatigue-critical areas of the Hercules wing.

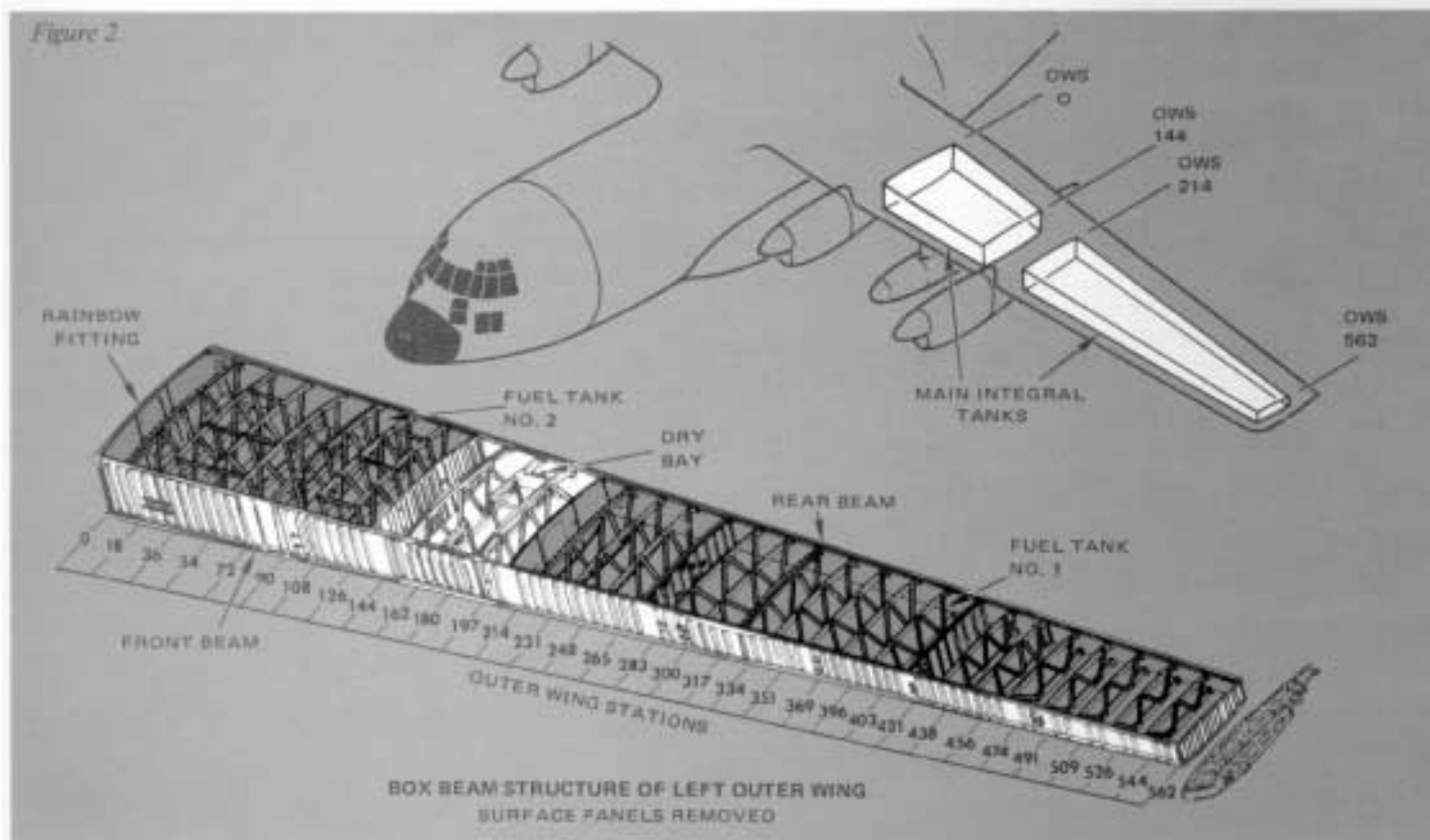













Figure 3

HISTORY OF FASTENERS USED IN HERCULES INTEGRAL WING TANKS

JOINT	LAC SERIAL	OUTER WING STATIONS	FASTENER TYPE	
UPPER AND LOWER RAINBOW FITTINGS TO SKIN PANELS	PRIOR TO 4195 AND 		LOCKBOLT	
	4195 AND UP AND ALL WITH 		TAPER-LOK	
RIB CAPS ATTACHED TO SKIN PANELS	PRIOR TO 4542 AND 		LOCKBOLT OR HI-LOK	
	4542 AND UP AND ALL WITH 		TAPER-LOK	
LAP JOINTS - UPPER SURFACE SKIN PANELS	PRIOR TO 4542	OWS 6 TO 216	STEEL LOCKBOLT	
		OWS 216 TO 562	ALUMINUM LOCKBOLT	
	4542 AND UP	OWS 6 TO 421	HUCKRIMP	
		OWS 421 TO 562	STEEL LOCKBOLT	
UPPER SURFACE SKIN PANEL TO BEAM CAP LAP JOINT	PRIOR TO 4542 	OWS 6 TO 216	STEEL LOCKBOLT	
		OWS 216 TO 562	ALUMINUM LOCKBOLT	
	PRIOR TO 4542 	OWS 6 TO 310	HUCKRIMP (OVERSIZE)	
		OWS 310 TO 562	ALUMINUM LOCKBOLT	
	4542 AND UP	OWS 6 TO 421	HUCKRIMP	
		OWS 421 TO 562	STEEL LOCKBOLT	
LAP JOINTS - LOWER SURFACE SKIN PANELS	PRIOR TO 4542 	OWS 6 TO 216	STEEL LOCKBOLT	
		OWS 216 TO 562	ALUMINUM LOCKBOLT	
	PRIOR TO 4542 	OWS 6 TO 300	HUCKRIMP (OVERSIZE)	
		OWS 300 TO 562	ALUMINUM LOCKBOLT	
	4542 AND UP	OWS 6 TO 386	HUCKRIMP	
OWS 386 TO 562		STEEL LOCKBOLT		
LOWER SURFACE SKIN PANEL TO BEAM CAP LAP JOINTS	PRIOR TO 4542 	OWS 6 TO 334	STEEL LOCKBOLT	
		OWS 334 TO 562	ALUMINUM LOCKBOLT	
	PRIOR TO 4542 	OWS 6 TO 302	HUCKRIMP (OVERSIZE)	
		OWS 302 TO 334	STEEL LOCKBOLT	
		OWS 334 TO 562	ALUMINUM LOCKBOLT	
	4542 AND Up	OWS 6 TO 386	HUCKRIMP	
		OWS 386 TO 562	STEEL LOCKBOLT	
FRONT BEAM WEB TO CAP SPLICES	PRIOR TO 4542 	WEB TO CAP - OWS 6 TO 300	2024-T31 RIVET	
		WEB TO CAP - OWS 300 TO 562	2117-T3 RIVET	
		STIFFENER TO WEB ONLY	7117-T3 RIVET	
		STIFFENER TO WEB AND CAP	STEEL LOCKBOLT	
		EXTERNAL TANK PYLON ATTACH. TO WEB AND CAP	STEEL LOCKBOLT	
	PRIOR TO 4542 	(SAME AS ABOVE WITH FOLLOWING EXCEPTIONS)		
		WEB TO CAP - OWS 58 TO 70 AND OWS 92 TO 104	HUCKRIMP (OVERSIZE)	
	4542 AND UP	WEB TO CAP - OWS 6 TO 18	TAPER-LOCK	
		WEB TO CAP - OWS 18 TO 351	STEEL LOCKBOLT	
		WEB TO CAP - OWS 351 TO 426	STEEL HI-LOK	
		WEB TO CAP - OWS 426 TO 562	2117-T3 RIVET	
REAR BEAM WEB TO CAP SPLICES	PRIOR TO 4542 - ALL	WEB TO CAP - OWS 6 TO 36	STEEL LOCKBOLT	
		WEB TO CAP - OWS 36 TO 401	2024-T3 RIVET	
		WEB TO CAP - OWS 401 TO 562	2117-T3 RIVET	
		STIFFENER TO WEB AND CAP	ALUMINUM LOCKBOLT	
		STIFFENER TO WEB ONLY	2117-T3 RIVET	
		EXTERNAL FUEL TANK ATTACH. FITTING TO WEB AND CAP	STEEL LOCKBOLT	
	4542 AND Up	WEB TO CAP - OWS 6 TO 18	TAPER-LOK	
		ALL ATTACHMENTS - OWS 18 TO 401	STEEL LOCKBOLT	
		ALL ATTACHMENTS - OWS 401 TO 456	STEEL HI-LOK	
		WEB TO CAP - OWS 456 TO 562	2117-T3 RIVET	
		STIFFENER TO WEB ONLY - OWS 6 TO 562	2117-T3 RIVET	
STIFFENER TO CAP AND WEB OWS 401 TO 562	STEEL LOCKBOLT			

 AIRCRAFT NOT MODIFIED BY T.O. 1C-130-857 (ECP 954)

A2 AIRCRAFT MODIFIED BY T.O. 1C-130-857 (ECP 954)

Figure 4

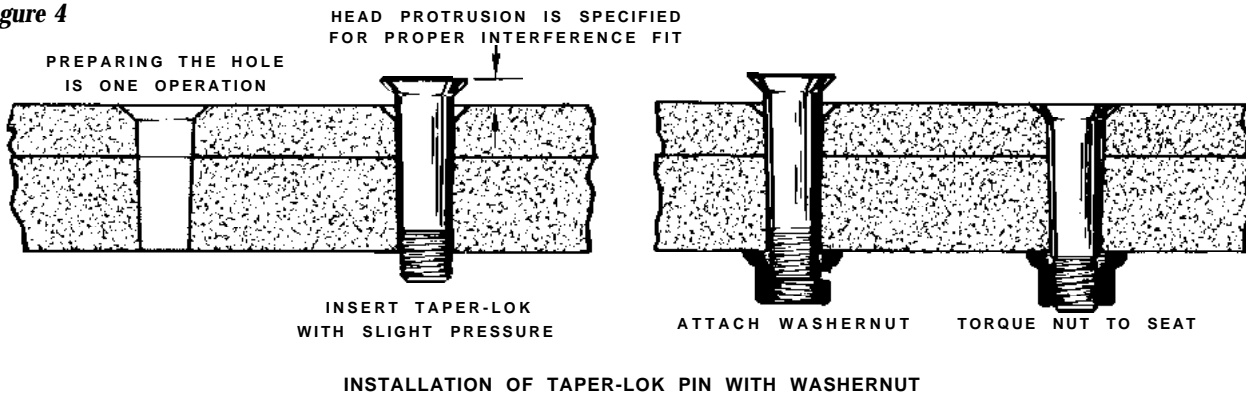

Structural Capability - This system achieves its fatigue enhancing features from the interference of the pin to the hole and the tension preload induced by the high torque applied to the Washernut.

Sealing - Fuel tank sealing with this system is accomplished by the interference of the pin in the hole. A properly installed pin in a properly prepared hole will not leak. Sealant is put on all fasteners prior to installation.

Installation and Removal of Taper-Loks - The condition of the Taper-Lok fastener hole is the most important consideration of the Taper-Lok fastener system. The hole is produced with a tapered reamer having an integral countersink or a radius on the reamer which creates the complete hole in one step (see Figure 5). The tapered pin is inserted into the hole with slight pressure and the pin head protrusion is measured to assure proper interference when the pin is fully seated.

Figure 5

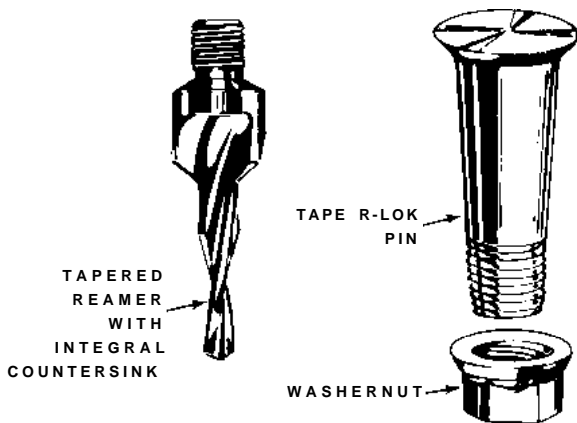

An additional check for hole quality is known as a dye check. Its purpose is to determine the amount of contact area between the pin and hole, and is used only when it is necessary to verify the quality. This check is accomplished by applying a dye to the pin shank and pressing

the pin into the hole, carefully removing the pin, and reading the contact of the hole on the surface of the pin. The pattern for an acceptable hole is shown in Figure 6.

After the proper protrusion and surface contact are assured, the pin is put into the hole and the Washernut is installed to a torque value specified in the structures manual. This seats the head and applies the proper tension preload in the joint.

Figure 6

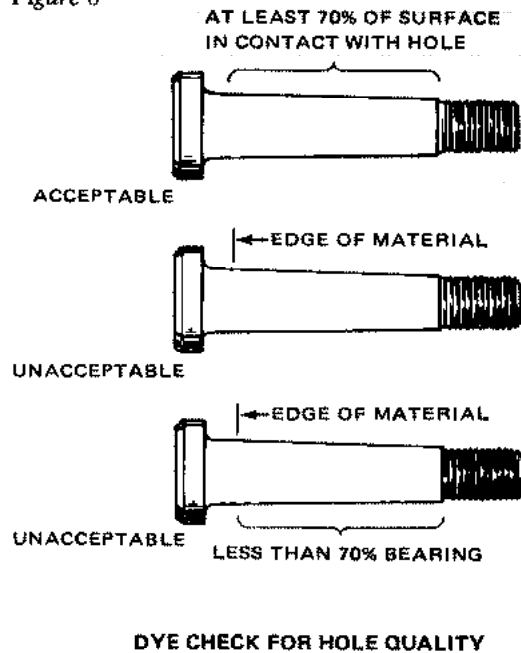

Removal of the tapered pin fastener assembly is a critical procedure and should be avoided if possible. A slightly improper installation is more acceptable than removal and reinstallation because most removal procedures risk damaging the structure or the hole. If a tapered pin must be removed and replaced, there is a removal procedure with special tools described in your Hercules Structural Repair Manual.

Figure 7

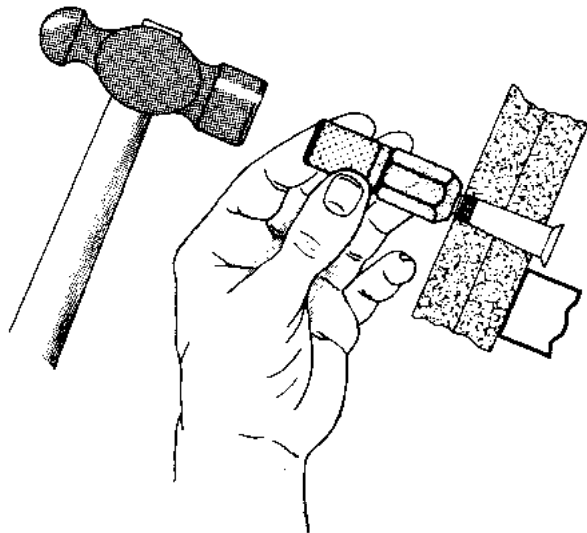

**THREADED REMOVAL TOOL
FOR TAPER-LOK TYPE FASTENERS**

Essentially, the removal procedure is as follows: The nut is removed and the shank is driven out of the hole with the proper tools (Figure 7). Be careful not to damage the nut-bearing area around the hole,

CAUTION

8 Do not attempt removal of Taper-Locks by drilling off the heads and punching out.

Use a knock-out tool and a hammer to remove the fastener. Back-up the structure with a bucking bar next to the fastener head, or a hollow bar over the pin.

Oversize Fasteners - Use oversize fasteners only when it is necessary to correct a poorly prepared hole or fastener installation. The use of oversize fasteners dictates that the hole be redrilled/reamed very carefully prior to the installation of the replacement fastener. Oversize fasteners may be needed due to material additions or to the use of thicker material. Both flush head and protruding head oversize repair tapered fasteners are available in basically a 1/64 inch larger shank diameter size than the standard fasteners. These are referred to as the first oversize. Also available for specific applications are second (double) oversize fasteners.

First Oversize

- NASI725(-)(-)/TL110(-)(-) - Flush Head
- NASI729(-)(-)/TL210(-)(-) - Protruding Head

Second Oversize

- TL130(-)(-) - Flush Head
- TL230(-)(-) - Protruding Head

The group number of the oversize fasteners is included in the part identification number on the fastener head. For a given grip length pin, the first oversize would have a group number one higher than the standard fastener. The second oversize would have a group number two higher than the standard fastener.

NOTE: It is recommended that the use of oversize tapered fasteners have prior engineering approval.

Huckrimp with Krimpnut

The pin is an alloy steel (108 ksi shear) with a straight shank very similar to a Hi-Lok, but with a domed head for higher tension load-carrying capability. It is installed in a straight hole with slight clearance or interference fit. The threads are designed to lock with the Krimpnut during installation. See Figure 8.

Figure 8

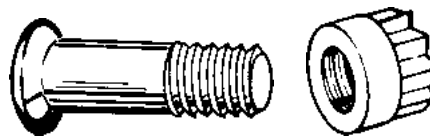

HUCKRIMP WITH KRIMPNUT

Structural Capability - The Huckrimp achieves its fatigue preventative features from a high tension preload (achieved when the Krimpnut collar is crimped on the pin) which produces high clamping forces between the parts being joined together.

Sealing - Fuel tank sealing with this system is achieved by firmly sealing the head and collar.

Installation and Removal of Huckrimps - Except for special crimping tools, which fit the regular Huck Lockbolt tools, the installation of Huckrimp is quite simple (see Figure 9). A straight hole is required and the pin is inserted into the hole; a slight interference is preferred, but not required, to hold the pin while the Krimpnut is pretorqued onto the pin. This pretorque of the Krimpnut is important - especially when uncured sealant is present in the joint and on the pin - before the crimping operation which causes the high tension preload in the joint. If the Krimpnut is not properly pretorqued, the required tension preload will not be achieved.

Removal of the Huckrimp assembly can be somewhat difficult because the pin will sometimes turn in the hole when an attempt is made to remove the collar (Krimpnut). When the pin turns in the hole, the collar must be cut off of the pin with a collar splitter (see Figure 10)

Figure 9

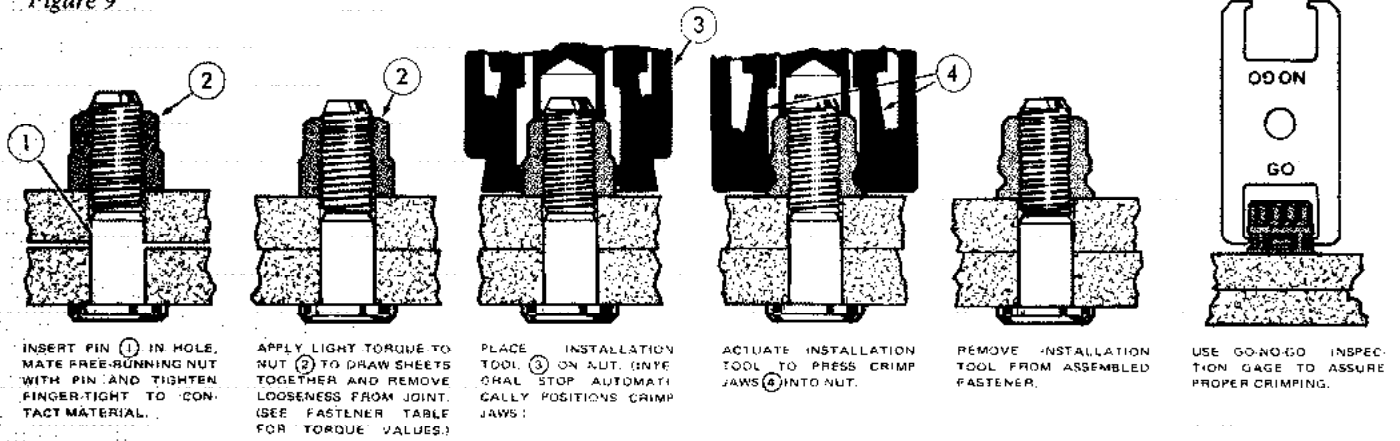

INSTALLATION SEQUENCE FOR HUCKRIMP FASTENING SYSTEM

or the pin must be drilled out from the nut side or, if inaccessible, the pin may be drilled from the head side with a drill slightly smaller than the pin.

Huckrimp replacement requires the same installation tooling with one exception. It is permissible to substitute a Washernut like the one used on Taper-Loks, in lieu of the Krimpnut, if the fastener is inaccessible for crimping, or if crimping tools are not available. The torque for a KFN542-3 nut in this type of installation is 45-55 inch-pounds.

CAUTION

Not using the proper Krimpnut or Washernut or not using correct torque values will degrade the fatigue prevention properties of this system.

Overize Fasteners - If the Huckrimps being replaced are of standard size there are 1/64 inch oversized repair fasteners available. If these overize repair fasteners have been initially installed, it will be necessary to go to the next larger size fastener.

NOTE: Use oversized Huckrimps only when needed to correct a poorly prepared hole.

Standard Huckrimp

NAS4466S(-)()/KS200DT - Flush Head

NA_S4458S(-)()/3KSPDT - Protruding Head

Overize Huckrimp

OKS200DT (-)() Flush Head

OJKSPDT(-)() Protruding Heading

Hi-Lok with Collar or Washernut

This pin is an alloy steel (05 ksi shear) with a straight shank very similar to the Huckrimp pin but with a flat shear head having less tension capability. The pin is installed in a straight hole with slight interference fit clearance and the collar is torqued until the hexagonal

Figure 10

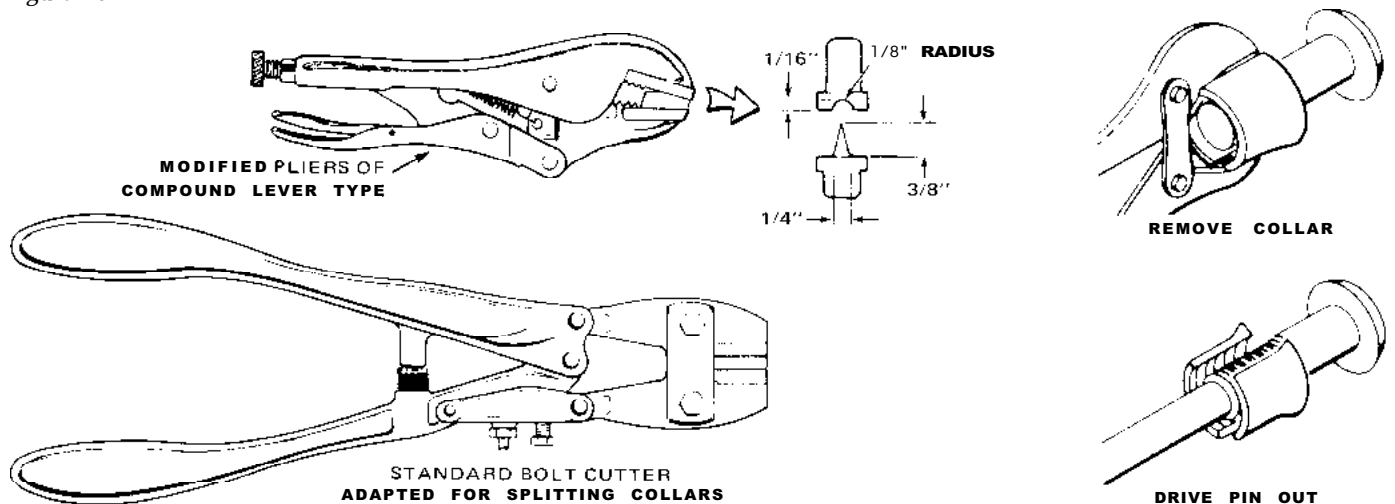

Figure 11



HI-LOK PIN WITH TORQUEOFF HEX COLLAR

must be installed to a specific torque value. See Figure 11.

Structural Capability – This system is used in structural applications where the fatigue preventative capabilities of the Taper-Loks or Huckrimps are not required.

Sealing – This system depends on the head and collar firmly seating to prevent fuel leaks. Properly installed, they will not leak.

Installation and Removal of Hi-Loks – Simple shop tooling is all that is required to install or to remove Hi-Loks. A slight pin interference is preferred but not required. The removal of Hi-Loks is quite simple. The aluminum torqueoff collar may be cut off or removed with pliers. After removal of the collar, the pin can usually be tapped back out of the hole since the interference is slight. Heavy interference should have a back-up block to prevent damage. If the hole is not damaged and within limits, another fastener can be reinstalled.

Repair fasteners shall be used only when specified or required. The installation requirements for repair fasteners and the standard fasteners are basically identical, except for hole size. Repair fasteners shall be of the same strength level as the fastener being replaced.

Oversize Fasteners – The same collar is suitable for standard, first oversize, and second oversize pins

First Oversize (1/64 inch)

HL62PB-()-() – Protruding Head

HL63PB-()-() – Flush Head

Second Oversize (1/32 inch)

HL218-()-() – Protruding Head

HL219-()-() – Flush Head

Lockbolt With Swage Collar

This pin is an alloy steel (95 ksi or 108 ksi shear) with a straight shank and is interchangeable with Hi-Lok pins. It is installed with Lockbolt tooling and has been in the aircraft inventory for more than 25 years. See Figure 12.

Structural Capability – This system is used in structural applications which are less fatigue sensitive than where Taper-Loks or Huckrimps are used.

Sealing – This system seals similar to Hi-Loks and will not leak if properly installed.

Installation and Removal of Lockbolts – This system requires a Lockbolt gun to pull the stem and to seat the collar. Otherwise, simple shop tools are all that are required. Removal is achieved by cutting the collar from the pin. Usually a “collar splitter” is used for this purpose (see Figure 10).

After removal of the collar, the pin can usually be tapped out of the hole, since the interference, if any, is usually slight. If a fastener has heavy interference, a back-up block should be used to prevent damage to the hole and to the surrounding metal. If the hole is not damaged and is still within limits, another like fastener can be installed.

Oversize or repair Lockbolts are not usually available. If an oversize fastener is needed, but the next standard size Lockbolt is too large, an oversize Hi-Lok can be used, with the appropriate torqueoff collar or nut.

Installation of the Hi-Lok should be accomplished in accordance with appropriate Hi-Lok requirements. Care must be exercised to ensure that the oversize or repair fastener is of equal strength to the Lockbolt being replaced.

Figure 12



LOCKBOLT WITH SWAGE COLLAR

Figure 13



NAS517 SCREW

Screws

The most common screws used on the Hercules wing are the NAS517 (see Figure 13). They are generally used when installation necessitates application by turning the shank rather than the nut. Screws, because of the recess in the head, usually have lower strength characteristics than other fasteners.

Usually, no problems are encountered in removing a screw, except in those cases where a recess is damaged. In those cases, it may be necessary to drill the head off and punch out the fastener stem; otherwise, the nut can be removed and the screw taken out of the hole. If installed in a nut plate; it can simply be unscrewed. If the fit is tight, slight tapping may be necessary although a clearance fit is usually involved if the pin is frozen in place by corrosion. In this latter case, it may be necessary to drill out the pin and replace the entire nut assembly.

Oversize Screws --- Oversize repair screws are required very infrequently. Some types are available in various head styles and strength levels. Usually, the next standard size screw is used, provided proper approvals are obtained.

A leaking screw could be an indication that someone has overtightened the screw, hence breaking the seal around the nut on the inside of the tank. One should never try to stop a fuel leak around a screw **head** by turning the screw unless he knows that the nut end is a dome nut or some type of mechanically sealed nut.

REMOVAL OF DIFFICULT FASTENERS

The threaded or stem end of some fasteners in sub-assemblies become almost inaccessible when assembled to other components. If it becomes necessary to remove one of these, the first problem is to remove the nut or sleeve that secures it.

If the fastener stem has an interference fit or is corroded, the next problem may be to force the stem back out of the hole. If the working space doesn't allow use of standard knockout tools, there is another approach, but it should be used only as a last resort.

A hole is drilled into the fastener body and threaded. A screw is then inserted in the hole and a slide hammer puller is used to withdraw the fastener. The hard and tough alloys of certain fasteners may present an extra challenge to the mechanic performing this operation. A typical pin puller/slide hammer type tool is shown in Figure 14.

Figure 14

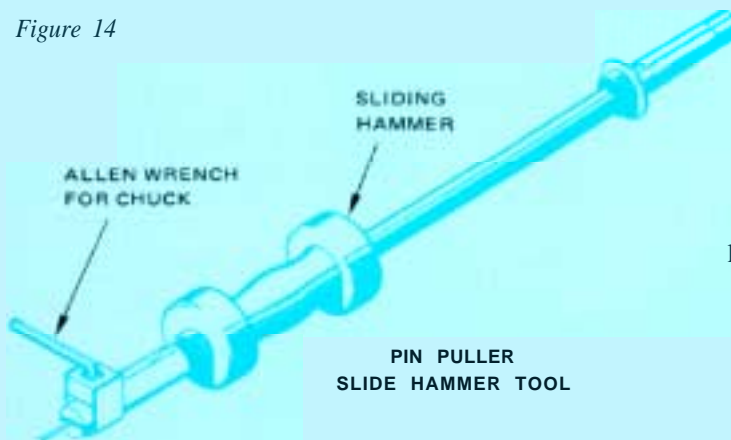

WET INSTALLATION OF FASTENERS

On later model Hercules, all fasteners penetrating the fuel tank boundary are "wet-installed" with sealant containing a corrosion inhibitor. The procedure for this operation is as follows:

Cleaning - All fastener holes contaminated with dirt, oil or other foreign matter are first cleaned. A clean rag, wet with a suitable solvent such as aliphatic naphtha or trichloroethane (O-T-620), will do the job.

NOTE: Fasteners lubricated with lauric acid or cetyl alcohol should not have this lubricant removed. These lubricants are compatible with the sealing materials used and are necessary to ensure the proper torque/tension required of the fasteners.

Sealant Application - Sealant is applied to the fastener shank in sufficient amount to ensure complete sealing of gaps between the fastened structure and all parts of the fastener systems; namely the pin, collar, nut washer, etc. Exuded sealant should be visible on both ends of the fastener after installation.

Fastener Installation - The following comments for specific types of fasteners supplement the above general requirements.

- 0 Rivets
After inserting rivet in hole, remove sealant from end of pin to facilitate upsetting of shank.
- 0 Hollow Blind Rivets
After wet installation, inject sealing compound into hollow shank to seal hollow blind rivet.
- 0 Lockbolts (Huckbolts)
Lockbolts with a vent groove cut through the locking grooves are designed to permit proper swaging of collars. Without the special vent grooves, sealant should be removed from locking grooves to swaging of collar.
- 0 Hi-Loks, Taper-Loks
The torqueoff collar, nut and Washernut used with these fasteners have a counterbore that must be completely filled with sealant. The pin should, therefore, be coated with sealant on the threads and 1/4 of the shank prior to installation to provide the necessary scaling protection.

Sealing Compound Cleanup - Excessive sealing compound on external surfaces should be removed with a rag lightly dampened with a suitable solvent such as methyl-

head.

Excessive sealing compound on fastener heads, or nuts, of fasteners located in fuel tanks should be removed as specified above so that brush coats of MILS-8802 sealant can be applied over these fasteners.

Sealing compound cleanup shall be accomplished as soon as possible after installation and prior to curing of sealant.

Installation Completion – Except for sealant cleanup, fasteners should not be exposed to air pressure, fuels, or other fluids until sealant has cured to a tack-free state.

Curing of sealants may be accelerated by application of heat up to 120°F. All sealants in the fuel tanks are then topcoated with a 0.001 to 0.003 inch coating of MIL-C-83019. This topcoat is then cured to a tack-free condition prior to refueling.

LEAK DETECTION AND REPAIR

All fuel leaks create hazardous conditions and must be repaired. Even small seeps, in confined areas, can be cause to ground an airplane. First, the leak should be classified. The following definitions and Figure 15 provide a good explanation of the various leaks:

Slow **seep** – Fuel does not immediately reappear after being wiped away. When it reappears, it may spread slightly but will not wet an area over three-fourths of an inch in diameter.

Seep – Fuel does not immediately reappear after being wiped away. When it does reappear, it will spread slowly on the surrounding surface and will not wet an area over one and one-half inches in diameter.

Heavy seep – Fuel immediately reappears after being wiped away and can be seen to spread on surrounding surface but does not drip or run from surface, nor spread over an area more than three inches in diameter.

Running Leak – Fuel immediately reappears after being wiped away and can be seen to spread on surrounding surface and drips or runs from the surface. This type leak requires the immediate grounding of aircraft for leak repair. Next, the type of repair to be made, temporary or permanent, should be decided upon and then the repair procedure determined.

The decision whether to make a permanent or a temporary repair depends upon the ground time available, the capability of the ground crew and/or the maintenance facilities available when the leak occurs, and the operational requirement for the airplane.

NOTE: A temporary repair is exactly that – temporary; and must be replaced with a permanent repair as soon as it is practical – generally at the next scheduled inspection, if not sooner. Some repairs may be approved only for a one time flight to a facility having the repair capability.

LEAK DETECTION

In most cases of fuel leakage, a temporary repair is first made in order to keep the airplane operational. These are external repairs, quick to make, and normally do not require defueling. These temporary repairs are made on the exterior surfaces at the obvious leak exit point. It should be noted that the leak may be “channeling” through faying surfaces, and stopping the leak at one point may force the leak to exist at another point. However, sealing of the faying surfaces has practically eliminated this “channeling”.

All permanent repairs are made on the interior of the fuel tanks; and in order to make them, the true leak source must be found. Before attempting to locate the leak source, first clean the interior joints opposite the leak exit point and closely inspect the condition of the sealant for breaks, cracks, pinholes or other defects that could possibly be causing the leaks.

12

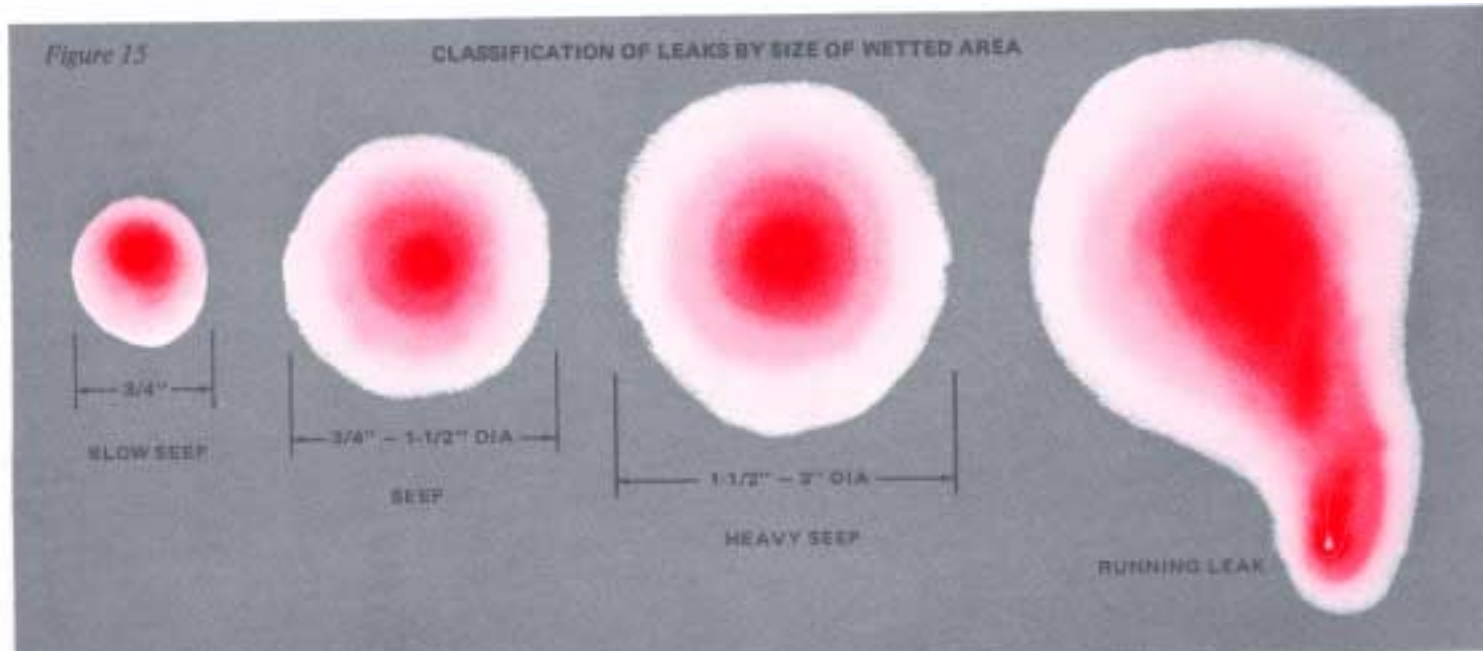

There are several methods of determining the leak source; however, the simplest and most widely used is the "blow back" method. In this method, compressed air (approximately 70 - 100 psi) is directed at the leak exit point (about an inch away from the fastener) while a co-worker inside the tank is applying a non-corrosive bubble solution to the joints and fastener patterns opposite the general area of the leak. Bubbles will indicate the leak source.

Remove the solution prior to making sealant repairs, and repeat the test after the repairs are completed to ensure that they have been effective. Again, remove the solution prior to refueling the aircraft.

Some other methods used for locating leak sources are as follows:

Dye injection from outside, using Oil Red "0" dye mixed with fuel (one ounce dye per 100 gallons fuel), or Zyflo ZL-22 mixed one part to ten parts fuel. This latter dye is fluorescent and requires an ultraviolet light for detection. Some methods utilize pressure on the outside to inject the dyed fluid through the leak path, while other methods utilize a light vacuum in the tank to draw the dyed fluid into the tank.

In all cases, once a repair has been made, the leak test should be repeated to ensure that an effective repair was made, prior to refueling the airplane.

LEAK REPAIRS

There are several different temporary repair methods for repairing leaky fasteners. Some are listed below:

- Aluminum foil repair method (dime/dollar patch)
- Pressure adapter method (for injecting sealant around leaky fasteners)
- Comp-Air tool number D236 (for injecting Lot-tite[®] around leaky fasteners)
- 9-L-Stop-A-Leak
- Oyltite Stick[®]

The most effective of the temporary repair methods is the first one listed, the aluminum foil repair method (Semco No. 400A kit); and the least effective is the last one, the Oyltite Stick. The procedure for making these temporary repairs is quite simple and is not covered in this article.

Permanent repairs, properly accomplished, should eliminate the leak and prevent recurrence. The first step is to locate the true leak source inside the tank. If the leak is

at a fastener, it should be closely inspected to determine that the fastener is sound. Unfortunately, there is no practical way of determining if a fastener was properly installed, if the hole was properly prepared, and of the correct size. Only a visible defect or looseness make it apparent that a fastener is unsound. Often, it is better to remove a suspect fastener and to replace it with one properly installed than to remove all the sealant around an existing fastener, reseal it, and still not cure the leak. Difficult to replace Taper-Loks represent exceptions if they are sound structurally.

If the fastener is not removed, the old sealant should be cut away using a sharp plastic (phenolic) tool and the area should then be cleaned using clean rags and clean solvent (trichloroethane, O-T-620, or Methyl ethyl ketone, TT-M-261). In order to promote optimum adhesion of sealant to polyurethane (MIL-C-27725) coated surfaces, a final wiping with clean rags dampened with PR146 or PR148 (Products Research Corporation) cleaner primer is recommended. Fasteners should be overcoated with two coats of MIL-S-8802, Class A sealant. If time permits, the first coat of sealant should be cured to a tack-free state before application of the second coat. If time does not permit, inspect the applied brush coat one hour after the first coat application for voids, pinholes or thin spots; and apply a second coat over the wet first coat, repairing all defects. After tack-free cure of the brush sealant, the sealant should be top-coated with MIL-C-83019 flexible polyurethane. This flexible polyurethane coating should be brush applied over all repair sealant, but should not extend over the MIL-C-27725 polyurethane tank coating for more than a fraction of an inch. This top coating has excellent adhesion to sealant and protects the sealant from degradation (chalking) by the fuel; however, its adhesion to the polyurethane tank coating is marginal. After curing of the top coating to a tack-free condition, the tank may be refueled.

If a leaky fastener is removed, the fastener hole should be cleaned of all residual sealant using a safety solvent and pure bristle brushes. A homemade phenolic cutter in a drill motor works very well in removing the sealant around the hole. The new fastener should be "wet-installed" with sealant. The hole should be checked to determine if it has the proper clearance or interference required for the fastener being installed. If the hole does not have the proper dimension, the fastener is likely to leak again. Lubricants applied on some fastener pins or collars by the manufacturer (cetyl alcohol or lauric acid) should not be removed. All other contamination should be removed. After wet-installation, the excess sealant squeeze-out on the inside of the fuel tanks should be removed to permit the proper brush coating of the fastener with MIL-S-8802, Class A.

NOTE: Do not use zinc-chromate inside a fuel tank.

Your Hercules Structural Repair Instruction manual should be referred to for more definitive instructions on fastener selection, replacement, and repairs.

SUMMARY

To conclude, if fuel is leaking at a fastener installation, it may be a warning that the fastener is not performing its primary structural function of carrying the loads induced into the structure. Extensive testing of structural fastener systems used in the C-130 Hercules wingbox indicates that when these fasteners are properly wet-installed in properly prepared holes, they will not leak. Although the brush overcoat of sealant, alone, is capable of temporarily stopping a fuel leak from around a defective fastener, it has been proven both in laboratory tests and by in-service experience that improperly installed fasteners can leak if the post-assembly brush seal is defective.

Properly installed fasteners are necessary to ensure that the wing attains its specified fatigue life goal.

Temporary repairs, although expedient to keep an airplane operational, should be replaced with permanent repairs as soon as practical; otherwise, the leakage rate will

continue to increase – all the old leaks plus developing new leaks. One leak, temporarily repaired fifteen times is recorded as fifteen leaks. If permanently repaired, the leak would have been eliminated, and considerable costs saved.

Reference:

CUSTOMER	TITLE AND DESIGNATION
Commercial Operators	Structural Repair Instructions SMP583 Section 51
U.S. Air Force	Structural Repair Instructions T.O. 1 C-1 30A-3 Technical Manual
	Preparation, Inspection and Repair of Aircraft Fuel, Oil and Water Alcohol Cells and Integral Tanks T.O. 1-I-3
U.S. Navy	Structural Repair Instructions NAVAIR R 01-75GAA-3 Technical Manual



StarTip

INSTALLATION TOOL – WING LEADING EDGE HINGE PIN

by Lou Clack, Shiraz Air Base

If you have ever removed the Hercules wing leading edge assembly, then you have faced the problem of replacing the hinge pin.

Here is a design for a locally fabricated tool to facilitate the hinge pin installation.

Material needed:

- ① Steel Tube: 1/2" O.D. X 7/16" I.D. X 48" Length
- ② Steel Tube: 3/8" O.D. X 5/16" I.D. X 48" Length
- ③ Rivet Set
- ④ Steel Rod: 1/4" Dia. x 48" Length

Weld the 1/4" solid steel rod to the rivet set on one end and drill a recess 1-1/2" X 1/8" in the other end. The hinge pin fits into the recess while the "bumping" or hammering is accomplished from the rivet set end. The different size steel

tubes support the rod and telescope within each other as the hinge pin is installed.

The end of the hinge pin being inserted should be tapered slightly to facilitate installation and to protect the hinge. Dry film lubricant should not be removed from the 302H steel pin-if it is, the pin should be sprayed with MIL-L-46147 dry film lubricant before installation.

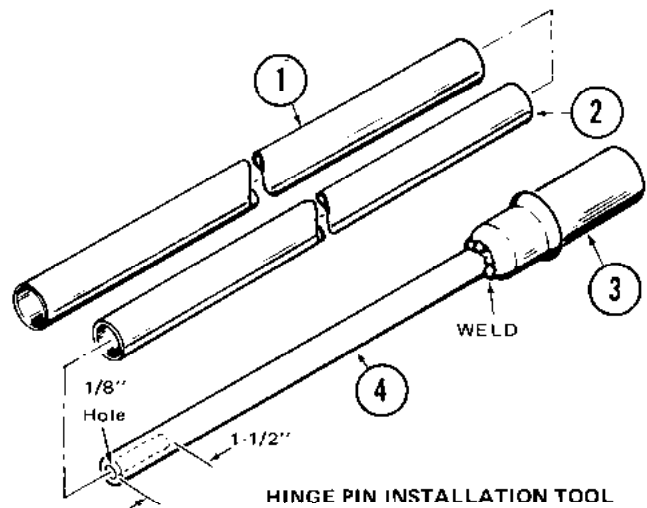

HINGE PIN INSTALLATION TOOL

REPAIR OF RUBBER COVERING ON *Inflight Refueling Hoses*

The following procedure may be used to repair the rubber covering on inflight refueling hose assemblies when the damage is limited to abrasions, cuts, or holes no larger than a dime in the exterior cover of P/N 149D5009 hose assemblies. This repair procedure is to be used only if the braided wire reinforcement of the hose shows no evidence of damage.

Repair as follows:

1. Remove any loose cover material and lightly bevel the damaged cover surface to about 1/2 inch out from the damaged area, using 400 grit abrasive sheet.
2. Wipe the abraded area with clean cloths dampened with 0-T-620 Trichloroethane and wipe dry with a clean cloth prior to solvent evaporation.
3. Mix polyurethane adhesive in accordance with the manufacturer's instructions and apply a sufficient quantity to the hose cover to completely fill and smooth the damaged area.

NOTE: Pot life of the mixed adhesive is one hour at 75°F and all applications of the adhesive must be completed within this period.

4. Cure the adhesive for 48 hours at 70' (+/-10')F or 3 hours at 150' (+/-10')F; then remove any excess by lightly sanding with 400-grit or finer abrasive sheet.
5. Brush coat the repaired area with MIL-P-11520 (or equal) rubber preservative coating, and cure for 4 hours at 70' (+/-10')F.
6. Carefully check completed repair to see that there are no bulges that will cause the hose to bind in the guillotine.

Polyurethane adhesive required to fill the damaged area of the hose cover is available from Lockheed-Georgia Company by stock number EPS C30.16 or from the following manufacturer as Uralane 5738A/BX.

Furnane Plastics, Inc.
5121 San Fernando Rd., W.
Los Angeles, California 90039



New Check Valve

SPECIFIED

for Hercules Hydraulic Pump Pressure Lines

Each of the pressure lines from the engine-driven hydraulic pumps contain a check valve, MS28892-10, located in the dry bay areas of the wing. Some of the suppliers of this valve have provided valves using aluminum seats. Our experience has shown that the aluminum seat does not have a long fatigue life when installed in this location due to pressure ripple from the pumps.

Lockheed is replacing this valve in production aircraft with another that uses a stainless steel poppet and seat, and is identified as P/N 448-1 OSS27-6.

The manufacturer is: Teledyne

Republic Manufacturing Company
15655 Brook Park Road
Cleveland, Ohio 44 142

Appropriate changes will be made to logistical handbooks and the new valve will be noted as a preferred spare. The aluminum seat type check valve should be replaced on an attrition basis.



2 ENGINE DRIVEN HYDRAULIC PUMP

2 ENGINE



CUSTOMER SERVICE DIVISION
LOCKHEED-GEORGIA COMPANY
A DIVISION OF LOCKHEED AIRCRAFT CORPORATION
MARIETTA, GEORGIA 30063



JetStar II HIGHLIGHTS – Lockheed-Georgia's new JetStar II received its Type Certificate on December 14, 1976, and in February of this year as part of a 10,000 mile tour, the JetStar II made a 3300 mile, non-stop flight from Honolulu to El Paso, Texas, in six hours, fifteen minutes. During the tour the JetStar visited many airports to demonstrate its quiet operation and economy.

The first customer delivery was to Allied Stores. Following delivery, the aircraft was flown to Executive Aviation where a custom interior was installed and the airplane is now in service.