



**Lockheed Martin Aeronautics Company**  
**Supplier Tooling Manual**  
**(Tool Manufacturing Specification - Material Control - 015)**  
**TMS-MC-015**

**Applicable to**  
**FORT WORTH – MARIETTA - PALMDALE**  
**Sites**  
**To the extent specified herein**

**REVISION 27**

CONTROLLED AND APPROVED BY:

**Lockheed Martin Aeronautics Company**  
**Supplier Quality Management**  
**February 2012**

IMPORTANT NOTICE: A hard copy of this document may not be the document currently in effect. The current version is ALWAYS the version on the LOCKHEED MARTIN network.

\* REVISED

\*\* ADDED

---

**\* TABLE OF CONTENTS**

**PART I. AIRCRAFT ITEMS AND TOOLING - SELLER REQUIREMENTS**

1.0	GENERAL	Page	5
2.0	TOOLING DEFINITIONS	Page	5
3.0	INTERCHANGEABLE-REPLACEABLE (I/R)	Page	8
4.0	"TO MATCH" HOLE PATTERNS AND OTHER I/R FEATURES	Page	11
5.0	CONTROL OF RECORDS FOR BUYER FURNISHED TOOLING	Page	11
6.0	CERTIFIED PROPERTY LIST (CPL) Form 11300	Page	12
7.0	CONTROL OF BUYER-FURNISHED TOOLS	Page	12
8.0	TOOL QUALITY CODE CATEGORIES	Page	14
9.0	TOOL PROTECTION AND STORAGE REQUIREMENTS	Page	14
10.0	SHIPPING INSTRUCTIONS	Page	14
11.0	TOOLING PERIODIC INSPECTION AND RE-VERIFICATION (PI/V)	Page	15
12.0	TOOLING PERIODIC INSPECTION AND RE-VERIFICATION (PI/V) RECORDS	Page	18
13.0	BUYER FURNISHED AND SELLER TO SELLER TRANSFER OF TOOLS	Page	18
14.0	LOCKHEED MARTIN SUBCONTRACT SOURCE BOOKS	Page	20

**PART II. MANUFACTURED SPECIAL TOOLING ONLY – SELLER REQUIREMENTS**

1.0	GENERAL	Page	21
2.0	DEFINITIONS	Page	21
3.0	SPECIAL TOOLING INSPECTION AND QUALITY REQUIREMENTS	Page	21
4.0	TOOL IDENTIFICATION AND SHIPPING REQUIREMENTS	Page	23
5.0	PROCESS FOR TRANSFER OF TOOL DESIGNS FROM SELLER TO BUYER	Page	24
6.0	SEALING CRITICAL LOCATORS	Page	24
7.0	DUPLICATE TOOL MANUFACTURING	Page	24

**TABLE OF CONTENTS (cont'd.)**

8.0 INTERCHANGEABLE- REPLACEABLE (I/R) DESIGN AND MANUFACTURING	Page 24
9.0 NON (I/R) AND NRE DESIGNS AND MANUFACTURING	Page 25

**PART III. INTERNATIONAL SELLER REQUIREMENTS**

1.0 GENERAL	Page 26
2.0 CONTROL OF SUPPORT EQUIPMENT (SE), MANUFACTURING TEST EQUIPMENT (MTE) AND SPECIAL TEST EQUIPMENT (STE)	Page 26
3.0 CHANGE AUTHORIZATION	Page 27
4.0 TOOLING PRACTICES FOR BUYER-FURNISHED TOOLS	Page 27
5.0 LISTINGS OF SELLER-FABRICATED/PROCURED ST OR STE	Page 27
6.0 DRAWINGS, SKETCHES, TOOL DESIGNS, ETC.	Page 27
7.0 CALIBRATION AND RE-CALIBRATION OF BUYER-FURNISHED OR SELLER-FABRICATED STE	Page 27
8.0 TOOLING USE AND TOLERANCE REQUIREMENTS	Page 28
9.0 QUALITY ASSURANCE REQUIREMENTS OF SELLER-OWNED OR SELLER-FABRICATED PRODUCTION TOOLING	Page 28

**PART IV. APPENDICES**

APPENDIX A – REWORK, REPAIR AND COORDINATION GUIDE	Page 29
--	---------

**LIST OF FIGURES**

1. DS-1017 I/R Identification Label	Page 9
2. Example of I/R Wear Groove Indicators	Page 9
3. I/R Hole identification Options	Page 10
4. I/R Hole identification Example	Page 10
5. "TO MATCH" HOLE PATTERNS	Page 11
6. I/R TOOL DESIGN REQUIREMENTS	Page 25
7. TOOLING HOLE TOLERANCE	Page 30
8. DOUBLE RAIL (INTERCHANGEABLE)	Page 31
9. DOUBLE RAIL (REPLACEABLE AND NON-I/R, NET OR WITH EXCESS	Page 31
10. SINGLE RAIL SETBACK TYPE	Page 32
11. PRODUCTION TOOL TO CONTROL TOOL	Page 36

**TABLES**

COORDINATION PIN TOLERANCE (I/R) – Table 1.0	Page 33
COORDINATION PIN TOLERANCE – Table 2.0	Page 34
PRODUCTION ITEM TO PRODUCTION TOOL – Table 3.0	Page 35

## APPLICABLE DOCUMENTS

- \* PM-4053 TOOLING MANUAL – Access limited due to Protected Data contained therein. Sellers contracted to fabricate or rework Special Tooling shall contact Buyer to submit access request. PM-4053 contains complete Lockheed Martin Aeronautics Buyer's design, manufacturing and preservation requirements that are only briefly described or illustrated in this Manual. Seller shall refer to PM-4053 for complete specifications when this TMS Manual is imposed on a Purchase Order. See Part I, section 1.0.

PURCHASE ORDER QUALITY APPENDIX "QX" – LM Aero Buyer quality requirements

- \* PO APPENDIX T – Special Tooling Identification requirements for Non Recurring Engineering (NRE) Tools.

16PP1957 - Order of Precedence for Control Media for Manufacture of the F-16.

16PP026 – Interchangeable and Replaceable (I/R) program document for F-16

5PD41327 - Order of Precedence for Control Media for Manufacture of the F-22.

- \*\* 2ZZA10000 – Order of Precedence for Control Media for Manufacture of the F-35.

## PART I

### AIRCRAFT ITEMS AND TOOLING - SELLER REQUIREMENTS

#### 1.0 GENERAL

- \* 1.1 This Tooling Manual ("Manual") is applicable in its entirety when this Purchase Order contains Quality Appendix QX. Any deviations from the requirements contained herein shall only be authorized by Buyer and when approval from respective management. This Manual contains the contractual requirements to properly control and maintain Buyer-furnished Tooling in conjunction with all Applicable Documents listed or referenced in this Manual. The term tooling comprises Special Tooling ("ST"), Support Equipment ("SE"), Manufacturing Support Equipment ("MSE"), Special Test Equipment ("STE") and Manufacturing Test Equipment ("MTE") for Buyer; as such terms are hereinafter defined, used to produce Items for Buyer. "Buyer's representative" shall mean the assigned Lockheed Martin Quality Representative responsible for on-site oversight of tool manufacturing, rework, repair, in-process acceptance and final acceptance of authorized task.
- \* 1.2 This Manual contains general and specific requirements that are applicable as specified in this Purchase Order ("PO") and other applicable documents. Tooling Manual PM-4053 takes precedence over all manufacturing and preservation requirements when conflicts exist between this Manual and PM-4053, if any. Right of access to PM-4053 is not necessary for all Sellers. Seller shall consult with Buyer and Quality Representative to determine validity for access capability, based upon PO requirements. Only Sellers contracted to perform airframe tooling task on a continual basis shall be granted access. The terms "Item" or its plural "Items", "PO", "Seller", and "Buyer" as used herein, have the same meaning as the terms "Work", "Contract", "SELLER", and "LOCKHEED MARTIN", respectively.
- 1.3 Access to this manual can be found on the Supply Chain Management Home Page at <http://www.lockheedmartin.com/us/aeronautics/materialmanagement.html> under Quality Requirements, Control Specs.
- 1.4 Seller shall immediately notify Buyers representative if and when Buyer authorizes the manufacture, rework or repair of any Special Tooling (ST) to support delivery of Items as specified in this PO. Buyer's representative shall determine the level of Buyer representative oversight required for in-process verification and or final acceptance of any such manufacturing, rework or repair.
- \*\* 1.5 Intra-Lockheed Martin Work Transfer Agreement (IWTA): The performing business unit (Seller) shall be responsible for establishing and maintaining requirements, procedure and process that ensures configuration control is maintained throughout the duration of this IWTA.

#### 2.0 TOOLING DEFINITIONS

- \* 2.1. ST means all jigs, dies, fixtures, molds, patterns, taps, gages or other equipment and manufacturing aids, and replacements which are of such a specialized nature that without substantial modification or alteration, their use is limited to the development or production of particular supplies or Items thereof, or the performance of particular services. All ST provided by Buyer shall be considered Buyer Furnished weather the ST is shipped to Seller or Seller is requested to manufacture on Buyers behalf by PO.
- 2.1.1 "Rework" - is determined to require rework if such tool fails to produce an acceptable feature due to an out of tolerance condition or Buyer authorizes a modification to alter configuration.
- 2.1.2 "Repair" - is determined to require repair if such tool it is broken, missing details or mechanisms do not function properly.

\*\* 2.1.3 “Non-Recurring Tools or Non-Recurring Engineering Tools” (NRE) - NRE tools are defined as ST tools authorized by Buyer only to facilitate manufacturing or delivery of Buyer items and shall be considered as Buyer Furnished Tooling. NRE Tools are further defined in Part II, Section 2.2.

2.2 Modification Kit Tool (“MKT”) is categorized as ST and used to update or modify aircraft assemblies and structures.

2.3 “Tooling Tools” means all gages used by Seller to control the fabrication or coordination of production tooling, holes, Interchangeable-Replaceable (“I/R”) features, critical mating points and surfaces or contours it represents. Tooling Tools are for tooling purposes only and shall not be used for production purposes.

\* 2.4 “Seller-Owned Tooling” means all ST and Tooling Tools owned by Seller and used in the process of fabricating, inspecting, assembling and coordinating of particular Items and/or tools as described in paragraphs 2.1 and 2.3. Seller-Owned ST is not to be confused with any form of Buyer Furnished Tooling. This is a tool owned by Seller and not owned by Lockheed Martin.

2.5 STE means either single or multipurpose integrated test Items engineered, designed, fabricated or modified to accomplish special purpose testing. STE consists of Items that are interconnected and interdependent so as to become a new functional entity for special testing purposes. STE excludes:

- Consumable property
- ST
- Facility Items (except necessary improvements for installing STE)
- Plant equipment Items used for general plant testing purposes

2.6 MSE is used in manufacturing operations to support, test or prove the functional operation of an Item.

2.7 MSE consists of the following types of Items and shall be considered United States (“U.S.”) Government property:

2.7.1 SE required to make an Item operational in its intended environment. SE includes the following:

- Common and Standard SE – For use on more than one type Item
- Peculiar or Non-Standard SE – For use on a peculiar or specific Item

2.7.2 MTE required for use in manufacturing operations to conduct tests and/or prove the functional operation of a specific Item. MTE is peculiar to manufacturing in that it is not normally used by Buyer to support the Item in an operational environment.

2.8 “Control Media” means tooling and electronic data used to control I/R and/or coordinating points and are categorized as follows:

2.8.1 “Master Tooling” – Master tool gages used to establish dimensions and features during manufacture of Production Tools which control I/R and/or coordination points of production Items. Unless Buyer has provided Seller with prior specific written authorization to do so, Seller shall not use Master Tooling for production purposes, i.e., Item verification, drilling, trimming or forming.

2.8.2 “Controlled Production Tooling” – Tooling such as jigs and fixtures used to establish dimensions and features of Items and which control I/R and/or coordination points of those Items.

2.8.3 “Electronic Data” – Computer-generated electronic data used to establish dimensions and features during manufacture of production tools which control I/R and also used during fabrication of production Items for control of I/R features, e.g., trim, attach holes.

2.9 Manufacturing Engineering Data Model ("MEDM") – An electronic Computer Aided Three-Dimensional Interactive Application ("CATIA") model used to fabricate designed or non-designed tools. The MEDM may contain contour, reference lines, attach pattern, periphery, tooling holes, text, etc. in any combination for tool fabrication and/or the tool design. The MEDM may contain specific inspection points designated by Buyer's Integrated Product Team ("IPT"). The inspection point coordinates can be recorded electronically and can be displayed on a paper plot of the MEDM. A Coordinate Measuring Machine ("CMM") or other inspection device control program may be created from the MEDMs containing inspection point information defined by Buyer.

2.10 "Production Tools" means jigs, fixtures, dies, and other tools made for use in manufacturing Items.

\*\* 2.10.1 "Convenience Tools" are typically Production Tools and are Buyer Furnished for the convenience of the Seller with an option to use for this PO. However, this type tool can also be a Tooling Tool to be used at the Seller's convenience for tool coordination or tool manufacturing.

2.11 Interchangeable-Alterable ("IA") Items mean controlled interchangeable manufactured Items that may require limited alteration of specific features or opening edges during installation. The alteration, if any required, may be the removal and/or addition of edge material. The alteration task is only accomplished during installation.

2.12 Electronic Supplier Problem and Resolution ("e-SPaR") - This online system is available on the Buyer's Supply Chain Management Homepage at <http://www.lockheedmartin.com/us/aeronautics/materialmanagement.html> and is the approved system for Seller to request information regarding PO requirements, including Engineering drawing clarifications, tool design clarifications and any related issue that does not pertain to a physical discrepancy within a tool.

\*\* 2.12.1 Examples of such submittals or request, but are not limited to, would be a request for Buyer to ship applicable coordinating tool to Seller for the purpose of accomplishing Production Tool to Master Tool coordination.

\*\* 2.12.2 Clarifying language within the PO, Tool Design or Build Package.

2.13 Seller Aircraft Tooling Report ("SATR")

2.13.1 A SATR is a document initiated by Seller to document a discrepant Buyer-furnished ST condition. Buyer shall reply with authorization for rework or repair, if required, of "out of engineering" discrepancies or conditions.

2.13.2 This online system is available on the Buyer's Supply Chain Management Homepage and was created to provide Seller with a traceable electronic means of reporting ST discrepancies and achieving disposition authorization from Buyer's program representative.

2.13.3 Access is granted by applying for an account on the Buyer's Supply Chain Management Homepage at <http://www.lockheedmartin.com/us/aeronautics/materialmanagement.html>. Highlight "Quality Requirements" and select "Corrective Action".

\* 2.13.4 Seller shall initiate a SATR to document physical discrepancies, request for deviation from specifications or special processes of Buyer-furnished or any Buyer authorized manufactured Tooling that is assigned an LM Aero asset number, including all rework, repair or alter authorizations.

\*\* 2.13.5 Seller shall make every attempt to correct any discrepancy discovered during any tool manufacturing of Buyer Furnished tools to ensure defect is corrected and meets design, if any, or manufacturing specifications and maintains contracted configuration prior to submitting a SATR. The SATR shall affect Sellers Quality Rating.

2.13.5.1 SATR's initiated to document the condition of tool upon receipt from Buyer or a worn or unusable condition shall not affect Sellers Quality Rating.

## 2.14 Order of Precedence

2.14.1 F-16 document 16PP1957 - "Order of Precedence for Control Media for Manufacture of the F-16" takes precedence over all engineering dimensional requirements where master tools conflict with engineering requirements.

2.14.2 F-22 document 5PD41327 – "Order of Precedence for Control Media for Manufacture of the F-22" provides direction for implementation and management of identified variations between engineering designs and F-22 Control Tooling.

\*\* 2.14.3 F-35, C-130, C-5 and P-3 program documents for "Order of Precedence for Control Media" is illustrated in PM-4053, section 3.1.

## 2.15 Tooling Manual PM-4053

\* 2.15.1 Tooling Manual PM-4053 is the Buyer's Manufacturing Specifications for Tooling. PM-4053 is "Protected Information" and access can be granted only to Sellers authorized to perform manufacturing, rework or repair of "specific" Buyer Furnished tooling on a continual basis. Sellers authorized to perform manufacturing, rework or repair on a limited basis may not be granted access. Access can be granted as determined by Buyer's Manufacturing Engineering organization.

2.15.2 To obtain access, Seller shall make a request to Buyer. Buyer will initiate the process of granting access by completing an internal Form # FWP5176 that is only found on the internal Intranet system.

\*\* 2.15.3 Tool design and manufacturing requirements set forth in PM-4053 are fully imposed when this Manual (TMS-MC-015) is referenced in a PO.

## 3.0 INTERCHANGEABLE- REPLACEABLE ("I/R")

\* 3.1 Seller shall comply with I/R requirements imposed by this PO or IWTA and shall place all production tools that controls an I/R feature into a periodic recall cycle as specified in this Manual.

3.2 "Interchangeable Items" – Interchangeable Items are completely finished and have designed/controlled features which allow them to be installed, removed, or replaced without alteration, misalignment, or damage to installed or adjoining Items. Interchangeable Items require only attaching means (bolts, nuts, screws, pins, etc.) to install. Interchangeable Items do not require any fabrication operations such as cutting, filing, drilling, hammering or forcing at the point of installation.

3.3 "Replaceable Items" – Replaceable Items are partially finished and have designed/controlled features which require alteration of the Items in addition to the normal application and/or methods of attachment at the point of installation. Such alterations are limited to specified areas and may include drilling, filing, trimming, bending, etc.

3.4 "Interchangeable Category Items" – Items so designated are typically Items which are attached by bolts or screws, readily removable and replaceable. Such Items are designed in such a manner that all like Items made within the engineering drawing tolerances will substitute one for another. Interchangeable Category Items are Items that are maintained by Seller through use of normal manufacturing methods and compliance with engineering drawing dimension tolerances, without the use of I/R Control Media.



- \* 3.5 Seller shall manufacture I/R production tooling, only from Buyer Furnished control media, e.g., Control Tools, Electronic Data and identify all production tooling establishing an I/R feature of a deliverable Item to Buyer as follows.
- I/R shall be fabricated per applicable program I/R program document for production tools
  - All I/R identification shall be applied using “Krylon #2101- Cherry Red” Paint
  - All applicable holes, cut-outs, perimeters, etc., of production tools shall be identified with a ¼” band of the specified paint for all programs except F-35 program, which requires a 1/8” band.
  - Tooling for the C-130, C-5 and P-3 programs is excluded from the requirement to paint I-R “features” RED for identification purposes, but shall require the DS-1017 Label for Fort Worth Tools or a GMN001, GMN002 or a GMN003 Label for Marietta Tools as specified and the features shall be identified on the assembly engineering drawing.
  - The paint shall not be applied to mating, locating or surfaces subject to wear.
  - A note applied to tool stating: “This Tool contains Interchangeable and/or Replaceable (I/R) Features in ½” high letters or as practical. Note should be clearly visible to anyone using the tool.
  - Use of the I-R Identification Label is acceptable as illustrated in Figure 1.

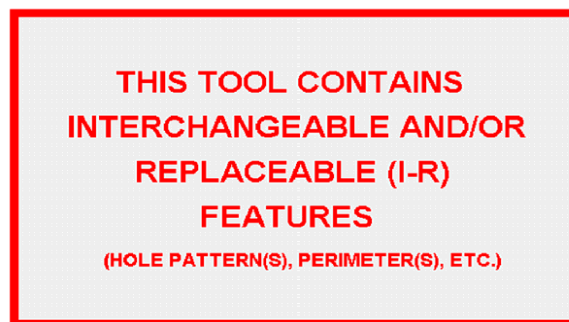


Figure 1. I/R Identification Label

3.6 Seller shall coordinate and re-verify configuration of I/R production tools as directed in Part IV of this manual or PM-4053.

3.7 In addition to the above identification, fiberglass Router Fixtures and Drill Fixtures shall have a special router guide surface which provides a visual indication of wear. The wear indicator consists of a groove cut into the I/R perimeter of the tool at a specified width and depth per illustration in Figure 2.

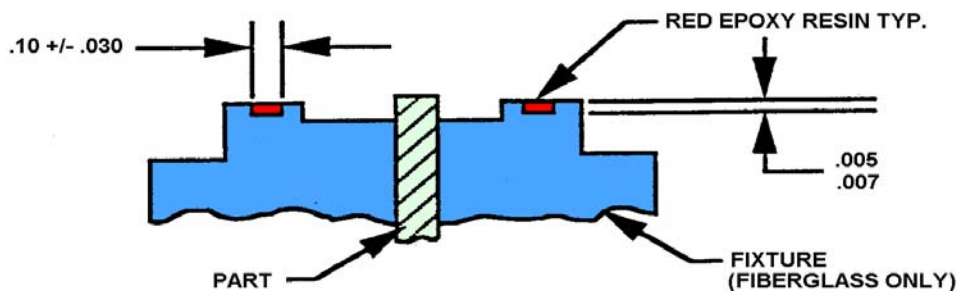


Figure 2. Example of I/R Wear Groove Indicators

\* 3.8 Seller shall identify F-35 I/R Holes with a 1/8" band of red paint around each hole or group of holes as illustrated in Figure 3 and Figure 4.

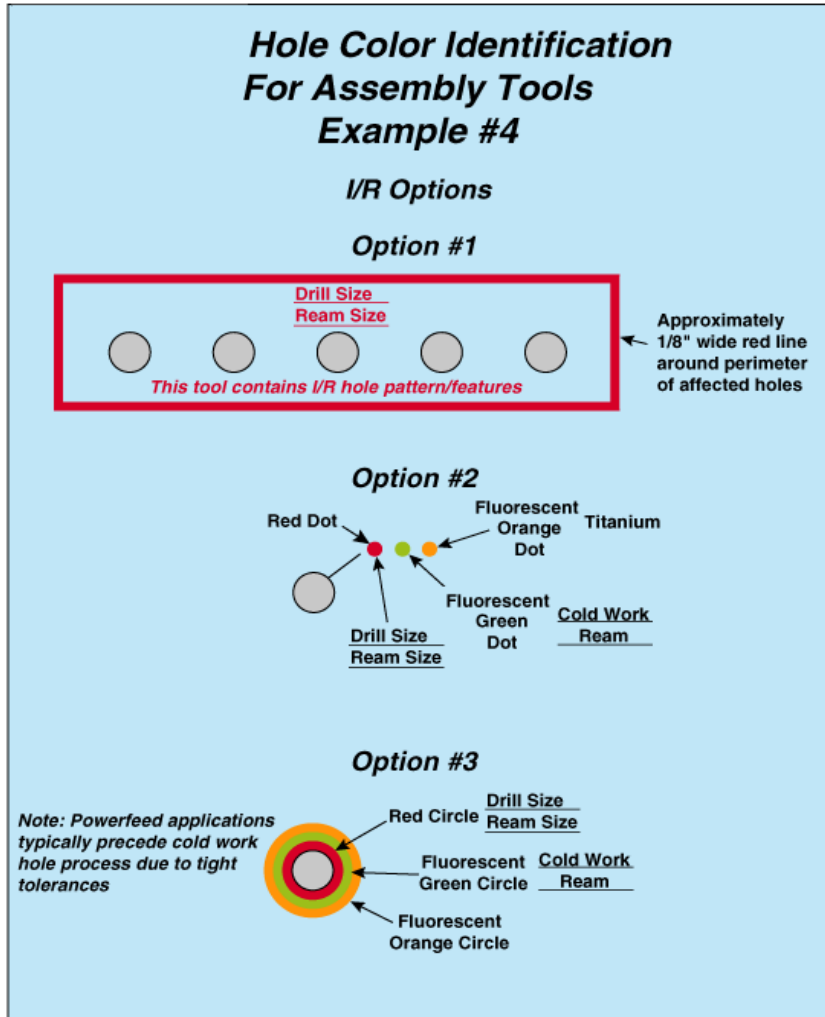


Figure 3. I/R Hole identification Options

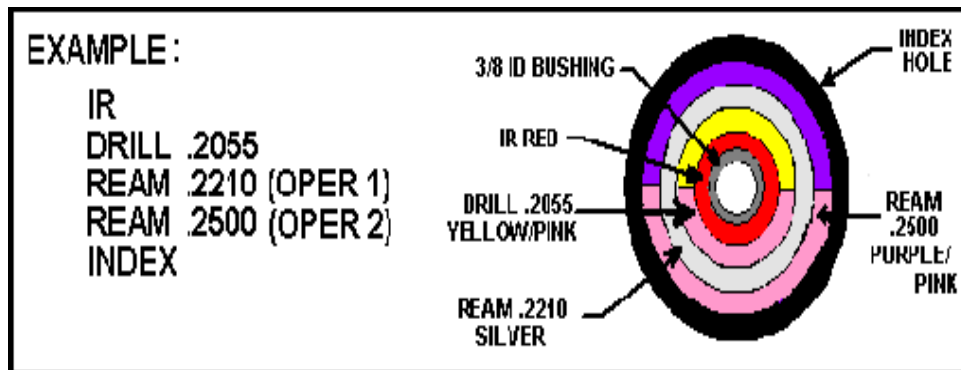


Figure 4. I/R Hole Identification Example

3.9 Seller shall place all I/R Production Tools into a Periodic Inspection recall cycle as specified in Part I, section 11.0 and 12.0 herein.

#### 4.0 “TO MATCH” HOLE PATTERNS AND OTHER I/R FEATURES

4.1 The term “To Match”, when specified on Buyer engineering drawings relative to hole locations, indicates that the dimensions including tolerances, even when met, may not necessarily ensure physical mating of Item hole patterns at the point of installation. This is true even though from a dimensional standpoint the features are within engineering drawing tolerance limits. “To Match” features are physically established, within engineering drawing tolerance limits, through the use of Master Tooling. Once Seller physically establishes the features, Seller must maintain the actual positions to achieve and sustain “To Match” capability (example in Figure 1).

4.2 Buyer’s Tooling specification, relative to Item features requiring physical control for configuration management purposes, is to provide Control Media, e.g., master gage, tooling gage, master plate, MEDM or other Electronic Data, to establish and maintain those Item features requiring control, over and above only the engineering drawing dimensions and their associated tolerances. If the Item feature requiring control has a critical configuration relationship requirement to other Item features, the Control Media will also establish those Item feature relationships, one to the other. Additionally, even though Item features may be within engineering drawing dimension tolerance band for those features, if an actual feature location does not comply with applicable Control Media allowed tolerance deviation, the feature location is not acceptable.

4.3 Buyer’s Control Media drawing, if applicable, will denote maximum tool deviations permitted in feature location and/or relation to critical features that are acceptable on finished Items.

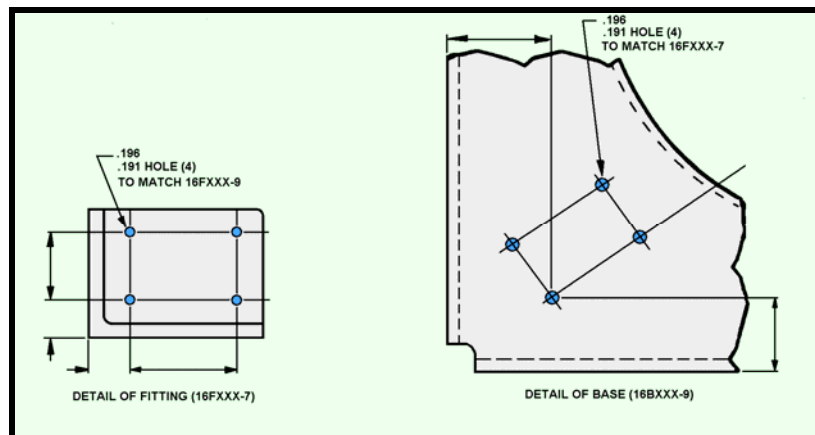


Figure 5. Example of “To Match” hole patterns as defined on engineering drawings.

#### 5.0 CONTROL OF RECORDS FOR BUYER FURNISHED TOOLING

\* 5.1 As a minimum requirement, Seller shall record the following information for property management control of Buyer Furnished tooling:

- Tool Number or Asset Number assigned by Buyer
- Buyer-assigned Item number and “Also Use” Item number/dash number that the tool will fabricate
- Tool Code
- Purchase Order number (or other authorization) under which the tool was furnished to or fabricated by Seller

- The Government or Commercial prime contract number indicated in this PO and, if applicable, type of Item (e.g., ST, STE, SE, MTE, etc.)
- Serial number of the shipping document for tools received by Seller from Buyer or another authorized party and all packing sheet information.
- Tool location within "Sellers" facility, rework, progressive inspection, calibration, maintenance and acceptance dates
- Copy of the completed Certified Property List CPL Form 11300 provided by Buyer
- Indication that tool is accountable to Buyer
- Authority for disposition of tools which are no longer in Seller's possession

5.2 Seller, on a current basis, shall maintain tool designs, sketches, photographs, and schematic drawings used in the fabrication, testing, or calibration of tooling. Seller shall show tool manufacturing tolerances on the tool design. Seller shall provide Buyer disposition for this data, as requested, at the same time disposition for related tooling is given.

- \* 5.3 Prior to any tool fabrication, Seller shall notify Buyer assigned Quality Representative, submit a copy of Seller's tool designs or concepts for Seller-owned and supplemental tools, including casting and forging tools, to Buyer for review and approval of concept for applicable tooling. If Buyer deems it necessary, Buyer, through its program Manufacturing Engineering, will provide concept or design changes to Seller.

## **6.0 CERTIFIED PROPERTY LIST – CPL FORM 11300**

- \* 6.1 Seller shall list tools authorized by this PO on CPL Form 11300, which is available on the Buyer's Supply Chain Management Homepage at <http://www.lockheedmartin.com/us/aeronautics/materialmanagement.html> under Quality Requirements. The CPL shall be current and contain all Buyer Furnished tooling for this PO, including Master Tools, Tooling Tools, Check Fixtures, Inspection Gages and Production Tools. The CPL shall be completed and returned to Buyer upon receipt of Buyer Furnished tooling or when tooling is authorized for manufacturing, reworked or re-stamped. The CPL is the form utilized by Buyer to record the location of Buyer and Government owned property. The Seller shall sign and stamp the CPL and forward the completed Form to Buyer without delay and without any further verification or signature by on-site Buyer representatives.

6.2 Certain types of tooling, as mutually determined by Seller and Buyer, are exempted from CPL accountability requirements. One example of exemption would be unique forging die tooling and potential Protected Seller manufacturing processes. Refer to paragraphs 5.1 through 5.3 for inventory/record requirements.

## **7.0 CONTROL OF BUYER-FURNISHED TOOLS**

- \* 7.1 Seller shall acknowledge receipt of all tool's, including ST, SE, MTE and STE, by the signature of an authorized representative of Seller on the CPL and return as requested by Buyer. Federal Acquisitions Regulation, FAR Part 45, 45.506, provides Sellers with specific instructions, as applicable to this PO.

7.1.1 Seller's Quality Management System (QMS) shall provide calibration or testing procedures capable of verifying configuration control of Seller-owned or Buyer-furnished Tooling, SE, MTE and STE.

7.1.2 Seller's QMS shall include Identification and configuration control procedures for Buyer Furnished ST.

7.1.3 Seller shall provide verification of compliance upon request from Buyer or Buyer representative.

7.1.4 Seller shall control tool traceability by ensuring all tool identification labels, plaques and removable details of tool are stored, handled, used and transported appropriately to prevent loss of any items associated with Buyer Furnished Tooling.

7.2 Upon receipt of boxed and sealed tools, Seller shall notify Buyer's Representative to break the seal of the container and visually inspect the tool and contents for completeness and/or damage. Seller's Quality Assurance (QA) personnel are allowed to open sealed containers in the event that Buyer's Representative is unavailable to support requested program need date(s).

\* 7.2.1 Seller shall complete form FWP-1209 "Tooling Gage Storage Record" accompanying Control Tools for Fort Worth or Form GD1856-1 "Tooling Log Book" for Marietta Control Tools, if Buyer's Representative is unable to perform this task. Production Tools will not have these documents enclosed in any container. Seller shall enter discrepancies, if any, in the remarks column. If Seller does not receive the applicable form with the tool, Seller shall initiate an e-SPaR requesting the correct form. These Forms are not available externally. Should one of these Forms be missing from the container, Seller shall immediately make request for replacement Forms from Buyer.

7.3 In no case shall Seller attempt to rework, in any manner, Buyer-furnished tooling without prior written authorization from Buyer.

7.3.1 Seller shall review Buyer authorization for repair and contact Buyer's Representative to discuss appropriate level of verification or oversight required by Buyer Representative to ensure that rework has been completed.

\* 7.3.2 All I/R tooling and tooling used as a media of acceptance/inspection shall require delta First Article Inspection (FAI) demonstrations upon completion of rework or repair, unless the reworked or repaired tool is coordinated to designated control media. Additional I/R and non-I/R repair, preservation and coordination guidance is provided, but not limited to, Part IV of this Manual.

7.3.3 Seller shall initiate a SATR to receive Buyer authorization for both rework and/or repair of Buyer-furnished ST.

\* 7.4 Seller shall maintain Buyer Furnished tooling in a usable condition capable of producing the original, or any subsequent Item configuration, including spares, unless changes made by Buyer's engineering are retroactive to the original point of effectivity of Item. Seller shall accomplish this by fabricating other Control Media for its use, or from Buyer-furnished Control Media.

7.5 When Buyer authorizes rework and/or modification and when a tool is capable of producing earlier configurations, Seller shall re-identify the tool to the new configuration Item number. When Buyer-authorized rework and/or modification will render a tool incapable of producing earlier configurations without extensive alteration, Seller shall notify Buyer prior to continuing any rework and request additional specific instructions for tool rework, or for potentially manufacturing new additional tooling.

7.6 Seller shall submit an e-SPaR with itemized listing of any Lost, Damaged, or Destroyed ("LDD") U.S. Government tooling to Buyer. Seller shall also include the following information on the e-SPaR submission for LDD tooling:

- A narrative description of the incident and corrective action taken to prevent recurrence
- Original Purchase Order number
- Original Purchase Order line Item number

- Original tool number – where applicable or for replacement of ST only
- Original Tool Code – where applicable or for replacement of ST only
- Original tool asset number (barcode number) – where applicable or for replacement of ST only

## **8.0 TOOL QUALITY CODE CATEGORIES**

\* 8.1 Seller shall fabricate all tools to the quality code stated in this PO. If no quality code is imposed or “Buyer Accept at Source” is not stated in this PO, Seller fabricated tools shall be quality Code 2 below and shall be identified as defined in Part II, paragraph 2.2.

- \*\* 8.1.1 Seller shall coordinate manufacturing of such tools with Buyer’s Assigned Quality Representative to establish applicable points of validation, inspection, coordination or verification, if any.

8.2 “Code 1” – These tools are made of the best and most durable practical materials available. They are capable of producing Items with critical tolerances at an accelerated production rate without addition or changes in construction. However, duplicate tools may be required by Buyer in some cases.

8.3 “Code 2” – Incomplete and/or low production rate quality tools that can be revised at a later date to meet the needs of an accelerated production program (capable of being reworked to Code 1 tools). Combined operational tools comparable to Code 1 tools used for performing multiple operations. Tools that can be revised by separating them into Items or sections to make one or more Code 1 tools if required by production scheduling.

8.4 “Code 3” – Permanent type tools made from moderately priced materials and used for low production rates or a limited number of ship requirements. These tools must be capable of holding blueprint tolerances. If production is greatly increased, it may be necessary to replace these tools when authorized to Code 1 or 2.

8.5 “Code 4” – Low production rate tools made of low cost materials. These tools are used for accomplishing emergency, temporary, or off-station production operations. They must be capable of making Items or assemblies that will meet minimum quality control standards. When making Items with this type of tooling, a maximum amount of handwork, standard setups, layouts, etc. is permitted.

8.6 “Code 5” – Lowest cost tooling that is used for production operations. These tools are needed for making Items or assemblies where it is impossible to make them by layout, handwork, standard tools, or setups. Use of handwork, standard clamps, etc., is permitted when finishing Items to meet engineering tolerances.

## \* **9.0 TOOL PROTECTION AND STORAGE REQUIREMENTS**

9.1 Seller shall ensure its quality system maintains surveillance in order that Control Media is not abused or damaged while out of storage/shipping containers. Seller shall be responsible for Buyer Furnished tooling while in Sellers possession and shall take particular care when tools are being stored, handled, transported, loaded into and removed from jigs and fixtures. Preservation, storage and shipping container requirements are illustrated in Part IV of this Manual.

## **10.0 SHIPPING INSTRUCTIONS**

10.1 Buyer shall specify destination and mode of transportation for tools that are to be shipped from any point of origin.

Note: Seller shall ensure all Tooling and shipping/storage containers are in usable condition prior to shipment. If either tool or shipping/storage container is not in usable condition, Seller shall initiate an e-SPaR for PO authorization to rework, repair or manufacture a new container and or a SATR for authorization to rework or repair a tool.

10.2 Seller shall provide advance notice to the Buyer's Representative when performing closure of a Control Media container.

\* 10.3 Seller shall contact Buyer's Representative for closure of the Control Media container. If Buyer's Representative is unavailable within two (2) business days to witness the closure of the Control Media container, Seller's QA shall fill out the Form FWP-1209 or GD1856-1 as applicable. Seller's QA and/or Buyer's Representative shall verify the following are complete and included before closure and sealing:

- A. Control Media contents are complete
- B. Applicable surfaces are greased/protected from the elements per Appendix A
- C. Loose details, i.e., L-pins, clamps, sub-assemblies, etc., are shored
- D. FWP1209 or GD1856-1 is stamped and complete

10.4 Prior to shipment, Seller shall note physical damage, if any, to any tool and shall document all such damage, if any, as specified in Part I, Paragraphs 2.12 and 2.13.

10.5 Seller shall use lead seals, steel stamped by Seller, to seal the Control Media container.

10.6 If movement of Control Media will affect Seller's ability to meet a delivery schedule, Seller shall immediately notify Buyer.

10.7 At such time Buyer determines that Buyer-furnished tools located at Seller's facility are to be dispositioned, Buyer shall list the tools and forward the listing, as appropriate, to Seller and Property Management, Subcontract Control Department. Upon receipt of the completed listing, Seller shall process the listed tools as follows:

- Segregate the tools to a secured storage area.
- Notify Property Management Subcontract Control of the specific location of the segregated tools and indicate the Seller representative that should be contacted regarding final disposition instructions.

10.8 Upon Buyer's written notification and transfer of tool title from Buyer to Seller, Seller shall remove all evidence of ownership markings from tools and tool containers or render markings unrecognizable. This tooling identification removal includes, but is not limited to, the following:

- Ownership markings on plaques
- Barcodes
- Steel stamping
- Vibro-engrave etching
- Paint markings

Seller shall reference FAR 45.506- Identification for contractor requirements of U.S. Government-owned property. Seller shall exercise caution to ensure that Tool Code and part number identifications are not removed.

## **11.0 TOOLING PERIODIC INSPECTION AND VERIFICATION (PI/V)**

\* 11.1 PI/V shall be a Seller process comprising the cyclical verification of "Selected Tooling" used as a media of acceptance for a feature(s) of an Item. Seller shall document and complete PI/V by a physical

coordination to designated Control Media annually or as specified by PO. Exceptions to an annual re-verification requirement are defined in 11.5.

- “Selected Tooling” is defined as any Buyer-furnished or Seller-owned tool used as a media of acceptance (inspection) for a feature of any Item deliverable to Buyer, where the feature of the Item established by this tool is not physically measured or inspected by other methods.
- Example of Selected Tooling that would be placed into a PI/V recall cycle: A Drill Jig (production Tool) used to drill four holes in an aircraft part and subsequently this Drill Jig is also used to verify the same four holes spacing, location, diameter, depth and Seller is not employing any other verification or inspection method to verify these features in the aircraft part.
- For the purpose of this Manual and specific to PI/V requirements, “annual” is defined as the duration of the PI/V cycle that shall not exceed one year from the previous date of PI/V.

11.1.1 Seller shall place all Buyer-furnished or Seller-owned Inspection Gages or Check Fixtures into a PI/V recall cycle.

11.1.2 Seller shall place all tooling that controls I/R into a PI/V recall cycle.

11.1.3 Seller shall utilize the coordination tolerances provided in Part IV of this Manual and PM-4053 or applicable coordination tolerance between tools specified by Buyer’s Tool Design.

11.1.4 Seller shall place all tooling used as a media of acceptance that establish features with an engineering or tooling tolerance of +/- .XXX” or .XXXX” into a PI/V recall cycle.

Note: If tool design includes a “Sheet 100”, the features specified on the sheet shall be re-verified on an annual basis, including all other features established by the tool that are not verified by physical inspection or other measurement methods.

11.1.5 Seller shall place all tooling, designated by PO to take precedence over engineering, into a PI/V recall cycle and all features established by tool shall be re-verified on an annual basis to maintain configuration control.

11.1.6 Seller shall verify any feature(s) of a tool, upon request by Buyer’s representative, to Tool Design or this PO requirement, if manufacturing discrepancies are documented and Corrective Action is requested by Buyer.

11.1.7 Seller’s PI/V documentation shall be a unique record system controlling the annual re-verification of Buyer Furnished and Seller Owned Production Tools, Check Gages and Inspection Gages

11.1.8 Any deviations from these mandatory requirements for PI/V shall only be authorized by written authorization from Buyer.

11.1.9 Seller shall verify the configuration integrity of Hammer Die’s, Form Die’s and other tools subject to high wear prior to and after each production run.

11.2 Seller shall be responsible for establishing a PI/V procedure for Buyer-furnished or Seller-owned tools used as a media of acceptance to produce Buyer Items and present proof of administering these procedures to Buyer or Buyer’s Representative upon request. Tools designated by Buyer as Master Tooling or Tooling Tools and used for coordinating purposes only, do not require PI/V but do require unique preservation controls to ensure configuration and integrity of tools are maintained. Preservation, maintenance and standard repair specifications are illustrated in Part IV of this Manual.



\*\* 11.2.1 Sellers working to an Intra-Lockheed Martin Work Transfer Agreement (IWTA) between Lockheed Martin Companies shall be responsible for establishing and maintaining PI/V requirements, a procedure and process that ensures configuration control is maintained throughout this IWTA.

11.3 Seller shall perform PI/V of Selected Tooling at Seller's facility annually if specific instructions are not provided by PO or IWTA. Seller shall review tool history after each PI/V to determine whether tool performance has been such that subsequent periodic cycles can be increased, remain as scheduled or be reduced. Seller shall coordinate any deviations from the annual requirement through Buyer by initiating an e-SPaR and subsequently receiving authorization from Buyer's Program Management. Seller shall receive deviation authorization only through PO revision.

\*\* 11.3.1 Sellers working under an IWTA shall use Request for Engineering Action (REA) System, only if applicable.

\*\* 11.3.2 Sellers working under an IWTA shall be responsible for control, preservation, PI/V and maintenance as defined in this manual and PM-4053 as applicable to Seller's Quality Management System and IWTA.

\* 11.4 Seller shall place all "Inactive" tooling used as a media of acceptance into storage and designate these tools as "Inactive". Seller shall perform PI/V on all "Inactive" tools prior to their being returned to "Active" status. If inactive tools are no longer required, Seller shall notify Buyer and Property Management for disposition instructions.

\* 11.5 With an exception to Sellers working to an IWTA, and only in the absence of designated Control Media, Seller shall accomplish PI/V by means of visual inspection in lieu of performing physical tooling coordination. Seller shall accomplish the visual PI/V using the below criteria.

- Seller shall use "Fit Check Items" or originally manufactured Items to the maximum extent possible.
- Seller shall obtain an up-to-date quality history data file for Item(s) affected by applicable tooling, and perform a quality analysis relative to any discrepancies which may be tool related. Seller shall take appropriate action based on analysis results.
- Seller shall perform a tool examination for obvious damage, excessive wear, broken, loose, worn, or missing Items, e.g., both integral and removable, bushings, pins, and clamps.
- Seller shall immediately identify any adverse conditions revealed as a result of the above actions and request direction from Buyer by submitting a SATR or using the REA system, if applicable.
- Seller shall determine any adverse affect on Items in work in Seller's inventory or delivered to Buyer; and take appropriate action to segregate, document and/or notify Buyer.
- Seller shall not consider shop floor planning operations, general review of tool prior to each use in a production environment or stamped off shop planning as evidence of performing PI/V.

11.6 Seller shall request from Buyer all necessary Tooling Tools to perform PI/V coordination to Control Media.

\* 11.7 Seller's digitization of Master Tooling or Tooling Tools is an acceptable alternative to Seller storing Master Tooling or Tooling Tools at Seller's facility for coordination activity. Digitizing data is a method of retaining the Master Tooling features for coordination activity. Seller shall use this digitized data to perform acceptance of features of Buyer deliverable Items. Digitized data, Master Tools, Tooling Tools and Control Tools do not require PI/V.

CAUTION: Digitized data is acceptable for this PO only. Seller shall verify that any additional PO's for the same deliverable Item is to the latest revision for Master Tooling or Tooling Tools. Seller shall verify the digitized masters are to the latest configuration. When performing coordination or verification of a physical tool to digitized data, applicable tolerances apply as if performing a tool-to-tool coordination. Tolerance requirements are illustrated in Part IV of this Manual.

## **12.0 TOOLING PERIODIC INSPECTION AND RE-VERIFICATION (PI/V) RECORDS**

12.1 Seller shall maintain a unique record for all tools requiring PI/V. Such record shall list:

- Tool Ownership ( LM Aero/ Supplier Owned)
- Buyer or Seller Tool Number
- Buyer or Seller Tool Code
- Buyer-assigned part number
- Next PI/V recall date
- Quality acceptance verification
- Control Media used, if applicable, shall be recorded in the PI/V record
- History of previous PI/V
- Date of PI/V
- PI/V check sheet (if applicable)
- Inactive tools

12.2 Upon Buyer or Buyer Representative's request, Seller shall present the PI/V record.

12.3 Seller shall update or revise the data in its PI/V record to meet the requirements of 12.1 on the next PI/V cycle of each tool.

## **13.0 BUYER FURNISHED TOOLING AND SELLER TO SELLER TRANSFER OF TOOLS**

13.1 Sellers authorized by Buyer to ship tools to another Seller shall ship tools according to Buyer authorization and Part I, section 10.0 of this Manual.

13.2 Sellers authorized by Buyer to receive tools from another Seller shall re-verify Buyer transferred or Buyer Furnished tooling per tool type requirements in PM-4053 in addition to the requirements set forth in this Manual for receipt of tooling in Part I, section 6.0.

13.3 Seller shall utilize the following guidelines for Major Assembly Jigs and Gages utilized for assembly as re-verification criteria upon receipt. Conformance to the following criteria, Tool Design drawing, PM-4053 and the specific Jig reference system values shall constitute satisfactory acceptance criteria;

- Visually inspect the jig upon receipt for obvious signs of damage sustained during shipment. All discrepancies or damage shall be documented and submitted to Buyer for rework/repair disposition, via Supplier Aircraft Tooling Report (SATR).
- Continue to locate the jig into position, if applicable, taking care to secure areas of the rough structure and avoid contact with locating features. Verify that the jig rests on all jack screws and jig feet provided.
- Rough level the jig using a conventional optical level and the leveling buttons located along the peripheral rough-structure near each jack screw. Allow the jig to sit over night (24 hours) to normalize to the environmental conditions under its own weight. Temperature and humidity readings shall be documented throughout the process if Laser verification is utilized for this process.

- Remove grease and/or other preservation treatments from the jig and loosen any pins and/or bushings that may have corroded during shipment.
- Install permanent details such as counter-balances, etc., that were temporarily removed for shipping and check to ensure proper function.
- Remove and establish storage means for removable details for each jig.
- Level the jig (horizontal plane) as necessary to maintain +/- .005 inches tolerance.
- Verify the plumb (vertical plane) of the jig to within +/- .005 inches tolerance. Use buttons where they are provided or the candlestick mounts common to the jig Lines Of Sight (LOS) for this purpose.

Note: It is sometimes necessary to adjust the level of the jig slightly in favor of the plumb in order to avoid excessive twist.

- Set-up and establish the jig reference system using the Laser Tracker targeting system (or equivalent) based on the coordinates provided on the jig. Target points and identification tags with values are stamped on each jig for this purpose.
- Measure the position of the candle-stick mounts, if applicable, per Tool Design drawing. Typically, there are four (4) mounts. Work from forward to aft along the Basic (lower) Line-Of-Sight (LOS) and then along the Auxiliary (upper) LOS. Observe squareness of the points and maintain within .005-inches total tolerance reading. The Auxiliary LOS is allowed run-out in the Z-axis (Water Line) but not in the X-axis (Buttock Line).
- Measure the position and alignment of the end-plates on the respective jigs to the basic and auxiliary LOS criteria per Tool Design drawing.
- Measure and create a y-axis (Fuselage Station) plane on the forward end-plate. The y-value should correspond to the nominal value shown on the tool design drawing and be planer within .010-inch total tolerance reading.
- Measure and create a y-axis (Fuselage Station) plane on the aft-ward end-plate as in the previous step. The y-value should correspond to the nominal value shown on the Tool Design drawing and be planer within .010-inch total reading. Observe the overall length of the jig between the end-plates and verify parallelism to +/- .010 inches tolerance.
- Anchor jig to floor as specified and illustrated in PM-4053, if applicable to tool type.
- Document all readings and/or damaged conditions noted in the steps per Part I, section 7.0 of this Manual.
- Submit SATR forms to document damage and out-of-tolerance conditions for rework/repair authorization, if any is required.
- Rework or repair any damaged tool details and out-of-tolerance conditions dispositioned by Buyer according to tool design drawing or special instructions. For C-130 and P-3 program, Seller shall make note of the completion of all verification points, inspection data and rework or repairs within the "Tooling Log Book" (GD1856-1) accompanying each jig.
- Perform additional inspection/verification items as requested by Buyer representative, if applicable.

- Establish periodic inspection points and records for future dimensional stability checks by verifying these key features during this initial set-up process. See Part I, section 11.0 of this Manual for PI/V requirements.
- Verify or install a new DS-228 Tool Identification Tag, if required on all tools per PM-4053, section 3.8. Stamping and dating of Tool Identification Tag shall be accomplished as directed by Buyer representative.
- Tool shall be placed into use for Trial Run/Tool Proof/FAI activity only.
- Tool shall not be released for Production service until successful Tool proofing activity is completed.

**\*\* 14.0 LOCKHEED MARTIN SUBCONTRACT SOURCE BOOK**

14.1 Subcontract Source Book's (SSB) are unique and are only applicable to LM Aero-Marietta's C-130 Program if specified by this PO and Buyers Statement of Work (SOW). Otherwise, the TMS Manual is fully imposed and shall take precedence when discrepancies exist between this Manual and the SSB when Quality Appendix QX is imposed, referenced or declared by this PO.

14.2 Any deviation or exceptions shall only be authorized by C-130 Program Management and shall be incorporated by PO revision or amendment. Clarification or deviation request shall be submitted as illustrated in Part I, section 2.12.

**END PART I**

## PART II

### MANUFACTURED SPECIAL TOOLING- SELLER REQUIREMENTS

**1.0 GENERAL** – Part II of this Manual is applicable to all domestic and international Sellers that manufacture, rework or repair ST and is in addition to requirements defined in Part I.

- \* 1.1 Buyer's tool design and manufacturing specifications are defined in PM-4053. Only Sellers authorized by PO to perform manufacturing, rework or repair are granted access to this Protected Data website. Seller shall contact its Buyer for access authorization. See Part I, section 2.15.

#### 2.0 DEFINITIONS

2.1 "REDLINE TOOL DESIGNS" – "Redline Tool Design" is a tool design drawing made by Buyer or Seller which has modifications marked in red ink. Such modifications provide clarification to tool fabrication changes and are known as "Redline Tool Design" changes. The redline change to the drawing is made with the understanding that a formal release incorporating the redline change(s) will be forthcoming. Detailed instructions about "Redline Tool Design" requirements are set forth in PM-4053.

- \* 2.2 Appendix T - is applicable "only" to "Non-Recurring" (NR) or "Non-Recurring Engineering" (NRE) Special Tooling and is imposed when Buyer has approved the manufacturing of Special Tooling. Appendix T is located on the Buyers Supply Chain Management homepage, <http://www.lockheedmartin.com/us/aeronautics/materialmanagement.html>, under Terms and Conditions.

- \* 2.2.1 Seller shall permanently identify all NR or NRE tools as specified in this PO. If specific identification and ownership requirements are not defined by this PO, then Seller shall identify NR or NRE tools per the following examples;

- a. Buyer Part Number/Dash Number: Example – 16B1944-29, 5HF45776-103, 2WSJ12345A1
- b. Buyer Tooling Number: Example - D12345, M081234, J1234567 or as directed by this PO.
- c. Ownership: Lockheed Martin or U.S. Government (as applicable) by this PO.

2.2.2 All Special Tooling covered by this PO, whether furnished to Seller or acquired or manufactured by Seller or its Subcontractor(s), is the property of the Buyer or the U.S. Government and shall not be used in the production, manufacture, or design of any article for any other use, unless the Buyer consents in writing. Buyer shall not consent to the use of Government-owned Special Tooling without prior written U.S. Government consent.

- \*\* 2.2.3 Careful consideration should be used in determining tool types for this PO. NR or NRE Special Tooling should be limited to Quality Code 2 through 5 as defined in Part I, section 8.0, as Low Dollar, Non-Critical, Non-Complex, Non-I/R, Non-LM Aero Designed, to minimize any potential manufacturing risk.

#### 3.0 SPECIAL TOOLING INSPECTION AND QUALITY REQUIREMENTS

3.1 Seller shall comply with stress relief, annealing, welding, and non-destructive inspection (NDI) operations in accordance with PM-4053. Seller shall flow the following instructions in Purchase Orders to their sub-tiers:

- Buyer identification number for Seller
- Buyer identification number for Seller's sub-tier (if applicable)
- All applicable Buyer-imposed specifications

3.2 Unless otherwise stated in Buyer's Build-to-Package ("BTP"), CMM, theodolite, photogrammetry, calibrated machine probe, and/or laser tracking are the only acceptable methods for contour verification, and are the preferred methods for hole pattern verification. CMM inspection is the overall preferred method for verification. Exception: If the CMM output data is such that the data is not electronically transmittable to a CATIA model for review, and/or calculations must be performed manually in order to complete the inspection activity (e.g., vector data must be manually calculated for hole locations), the use of theodolites or laser tracking when the data can be readily uploaded electronically to CATIA are then the preferred methods of inspection.

3.3 Inspection Grid Pattern: Unless otherwise stated in Buyer's BTP or specified in PM-4053, Seller shall inspect surfaces requiring verification using the following grid pattern:

3.3.1 A maximum distance of two (2) inches between points along contour for complex and/or compound surfaces. There are no minimum distance requirements.

3.3.2 A maximum distance of six (6) inches between points for planar surfaces. There are no minimum distance requirements.

3.4 Seller shall not proceed to the next verification milestone without prior written authorization by Buyer's Representative in the Progressive Inspection Log ("PIL"), or an equivalent log.

3.5 Seller shall establish and/or maintain a quality system which requires the inspection of all dimensions of a tool. Seller's QA shall log all three (3) place dimensions, (2 place for metric) or any dimensions specifically identified for inclusion in Buyer's BTP, into the PIL, but is not required to log one (1) and two (2) place dimensions, (1 place for metric) in the PIL.

3.6 Seller shall include a statement in the PIL to document inspection and acceptance of all one and two place dimensions, (1 place for metric).

3.7 Seller shall document tooling anomalies, requests for deviation or waiver, and other non-conformances, if any, identified during or subsequent to Seller's tool manufacturing and acceptance process by submitting a SATR.

\* 3.8 Seller shall plan the following criteria as inspection points and milestones that Seller shall present or provide as verification to Buyer's Representative prior to final acceptance, final approval or final certification, or as otherwise specified by this PO. The following criteria are not all inclusive and shall be reviewed and discussed between Seller and Buyer representative upon Seller's receipt of this PO.

- Verify closure of all SATR's and E-SPaR's
- Verify 95% Tool Design approval from Buyer, if applicable
- Verify Tool Plaque is stamped in the correct blocks releasing the tool for Trial Run or Production use per PM-4053
- Verify Special Processes, if applicable, are performed per PM-4053, i.e., NDI, Heat Treat, etc.
- Verify paint application per PM-4053
- Verify flow-down of requirements to sub-tier suppliers, if any, per Appendix QX
- Verify, the applicability of a "Delta" FAI or Fit Check requirement for all rework or repair authorizations
- Verify coordination of tool, if applicable, to Control Tools per Tool Design and PM-4053
- Verify all inspection data, electronic and mechanical, have been documented and prepared for shipment with tool, if applicable
- Verify Tool identification is per this PO and/or PM-4053 as applicable
- Verify ownership marking is per this PO and/or PM-4053 as applicable
- Verify loose details are stored and shored per PM-4053

- Verify loose details are identified per program requirements per PM-4053
- Verify I/R markings are per PM-4053 and that Tool Design clearly identifies I/R features and flag notes are used for identifying these features per this Manual in Part II, section 8.0 for production tools
- Verify I/R identification on tool contains mandatory I/R statement per PM-4053
- Verify if PI/V identification is noted on tool plaque, if applicable
- Verify Heat Thermal Survey applicability per PM-4053
- Verify material certifications, Certificates of Conformance (C of C)
- Verify Progressive Inspection Logs have been completed as required in this Manual
- Verify applicable leak checks have been performed per PM-4053, as applicable
- Verify fiberglass plies and resin are per PM-4053 requirements, if applicable
- Verify potting compounds used for bushing placement per PM-4053, if applicable
- Verify all potted bushings coordinate to coordinating tool per PM-4053
- Verify all hole and drill bushing identification is per Tool Design
- Verify Shipping/Storage container per Tool Design and PM-4053, if applicable
- Verify Shipping documents are correct per this Manual and Buyers Shipping Requirement PM-5010 or as specified by Buyer in this PO
- Verify tool protection requirements have been accomplished per PM-4053 for shipment to final designation, e.g., Overseas, Domestic.

\* 3.9 Seller shall stamp the DS228 Tool Identification Plaque as defined in PM-4053 for tool identification by placing Seller quality stamp and date in the Trial Run block if Trial Run Type I, II or III are specified on this PO. If Trial Run Type IV is specified on this PO, Seller shall place "N/A" in the Trial Run block and place Seller quality stamp and date in the Production block. Tool identification plaque requirements are fully illustrated in PM-4053, section 3.8. Trial Run is the process of verification that the tool functions as necessary to produce a part or assembly per engineering requirements in a production environment.

3.10 Trial Run is applicable as listed below.

- Type I            Trial Run Required
- Type II          Trial Run Required
- Type III         Trial Run Required
- Type IV         Trial Run Not Required

#### 4.0 TOOL IDENTIFICATION AND SHIPPING REQUIREMENTS

4.1 Tool identification for Buyer tooling is controlled by PM-4053. Seller shall check for the latest revision of PM-4053 requirements by visiting the on-line revision history link located on the Buyer's BTP website.

4.2 Seller shall identify each Seller-manufactured ST in a conspicuous place using a permanent method such as stamping, engraving, etching, stenciling, etc. as required per PM-4053.

4.3 To ensure applicable inspection data and acceptance reports remain with tool once received at LM Aeronautics facilities, Seller shall secure all technical, inspection and acceptance data reports in a sealed envelope. The sealed envelope shall include the following note on the outside of the envelope: "**These documents to Remain with Tool – Do Not Remove**".

4.4 Seller shall package, preserve and protect all tooling designated to be shipped overseas as directed in this PO and PM-4053, section 3.16.

## 5.0 PROCESS FOR TRANSFERRING TOOL DESIGNS FROM SELLER TO BUYER

5.1 Digital Data Transfer – The transfer of digital data between Seller and Buyer is controlled through Buyer's BTP Computer Aided Design/Computer Aided Manufacturing (CAD/CAM) Engineering Data Transfer Group. Buyer shall identify Seller Points Of Contact ("POC") for setup of digital data transfer capabilities and forward this information to Buyer's BTP CAD/CAM Engineering Data Transfer Group. Buyer's BTP CAD/CAM Engineering Data Transfer Group shall contact Seller POCs and identify required capabilities, data transfer site information, (including passwords, directory information, email notifications, and access controls), and how Seller will be notified of data transfer activities.

- \* 5.2 Hardcopy Data Transfer – Seller shall coordinate all hard copy transfer of designs through Buyer if required by this PO.

## 6.0 SEALING CRITICAL LOCATORS

6.1 Torque seal requirements for tooling are defined by site and program as illustrated;

- Fort Worth requirements: F-22A tooling – **Pink**  
All other tooling – **Purple**
- Marietta requirements: Tooling – **Pink**
- Palmdale requirements: Tooling – **Pink**
- All torque seal applications that are not for sealing locators or critical locating features can be White.

## 7.0 DUPLICATE TOOL MANUFACTURING

7.1 Seller shall manufacture duplicates of LM Aero tools, when authorized by Buyer, and shall verify that the original LM Aero tool matches the original tool design before proceeding with duplication task.

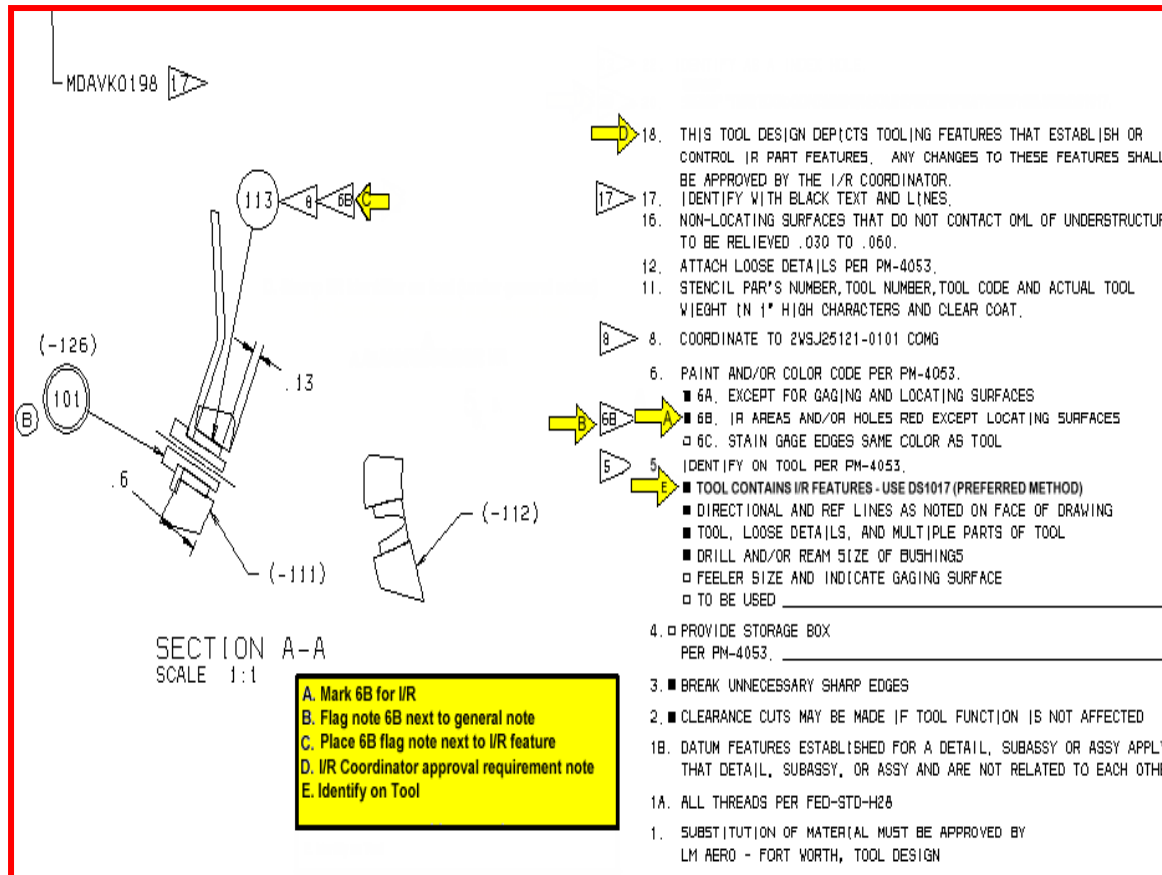
7.2 Seller shall notify Buyer if discrepancies exist between Tool and Tool Design as required in Part I, section 2.13.

## \* 8.0 INTERCHANGEABLE- REPLACEABLE ("I/R") DESIGN AND MANUFACTURING

8.1 Seller shall design and manufacture all tooling containing I/R features as defined in PM-4053.

8.2 Seller of Buyer authorized "design and build" tooling shall design I/R tools as illustrated in Figure 6 and PM-4053 Section 2.4.





**Figure 6. I-R Tool Design Requirements**

**\*\* 9.0 NON Interchangeable or Replaceable (I/R), NRE DESIGN AND MANUFACTURING**

9.1 Seller shall receive written authorization to design and manufacture tools once submittal of design, sketch, drawing, concept or schematics have been approved by Buyer's program personnel.

9.2 Seller shall notify Buyer Quality Representative when written authorization has been received. Seller's Buyer Quality Representative shall jointly develop an applicable validation process of all special processes, critical dimensions, leak checks or any unique point in the manufacturing process.

**END PART II**

## **PART III**

### **INTERNATIONAL SELLER REQUIREMENTS**

#### **1.0 GENERAL**

1.1 Part III is applicable to programs in which Buyer furnishes Seller with Items and/or material to support Buyer's BTP and is in addition to the requirements of Part I and Part II of this manual.

1.2 Fabrication requirements of ST, STE, and MKT by Seller or Seller's sub-tiers to produce Buyer-designed controlled Items and aircraft modifications, as specifically contracted by this PO, are defined in Part II of this Manual and controlled by PM-4053.

#### **2.0 CONTROL OF SE, MTE AND STE**

2.1 Receipt of SE – Seller shall return a stamped copy of SE receiver to Buyer within five (5) working days upon receipt of SE.

2.1.1 Maintenance and repair parts for SE – Seller shall requisition maintenance and repair parts for the SE provided as MSE from Buyer.

2.1.2 Modification of SE provided as MSE peculiar modification of SE – Seller shall receive a tool order, a peculiar modification kit and written Buyer authorization. Upon completion of modification, Seller will return the stamped off / approved copy of the tool order to Buyer.

2.1.3 Time Compliance Tech Order ("TCTO") modification of SE – Seller shall receive a TCTO modification kit and written authorization from Buyer authorizing Seller to install the kit. Upon completion of kit installation, Seller shall return a completed Letter of Certification ("LOC") to Buyer.

2.2 Receipt of MTE – Seller shall acknowledge receipt of the CPL by signing and returning the original CPL to Buyer.

2.2.1 Maintenance and Repair parts for MTE – Seller shall requisition maintenance and repair parts for the MTE from Buyer.

2.2.2 Modification of MTE – Seller shall not perform modification on MTE without prior written authorization from Buyer.

2.3 Receipt, Maintenance and Modification of STE other than MTE Receipt – Seller shall acknowledge receipt of STE, if any, by signing and returning the original CPL to Buyer within five (5) working days after receipt of STE.

2.3.1 Maintenance and Repair Parts – Seller shall requisition maintenance and repair parts for STE from Buyer.

2.3.2 Modification – Seller shall not perform modification of STE without prior written authorization and direction from Buyer.

2.4 Disposition of SE, MTE and STE – Seller shall request disposition instructions from Buyer when SE, MTE and STE become surplus or obsolete.

### **3.0 CHANGE AUTHORIZATION**

- \* 3.1 Seller shall not rework, repair or in any way alter control tools without prior Buyer written authorization in this PO or in a SATR disposition with a revised CPL and tool drawings, if required, to rework and/or re-stamp control tools per PM-4053, section 10.0.
- \* 3.2 Seller shall return to Buyer the stamped and signed Tool Rework Form document and CPL upon completion of Buyer authorized rework or repair per PM-4053, section 10.0.

**4.0 TOOLING PRACTICES FOR BUYER-FURNISHED TOOLS** – Category “A” tools are control tools that establish dimensions and features of production tools which control I/R and/or coordination points of other production tools. Seller shall use these tools as Control Media only to fabricate production and inspection tools. The following is a list of the affected tools:

- COMG – Component Master Gage
- FCGA – Facility Gage
- MSFM/TOFM - For contour only. Lines on MSFM/TOFM are for reference only and
- Seller may revise or add these lines to satisfy their production tool requirements without prior written authorization from Buyer.
- MSGA – Master Gage
- MSPE – Master Plate
- PDSE – Production Samples (Tube)
- TOGA – Tooling Gage
- TOSE – Tooling Sample (Welded Tubes/Ducts)
- Any tool identified by this PO and provided as a control tool

### **5.0 LISTINGS OF SELLER-FABRICATED/PROCURED ST OR STE**

5.1 Seller shall establish and maintain a part list and tool list, by manufacturer's part number, of ST or STE fabricated or procured by Seller, as required by Buyer. Seller shall not include any Buyer-furnished ST or STE in the list(s).

5.2 Seller shall produce and maintain listings of all tools required to fabricate Federal Identification Item Number (“FIIN”) spare Items.

### **6.0 DRAWINGS, SKETCHES, TOOL DESIGNS, ETC.**

6.1 Seller shall maintain Seller-owned or Buyer-furnished current tool designs, sketches, photographs, and schematic drawings used in the fabrication, testing, or calibration of tooling. Seller shall provide a disposition of this data at the same time disposition for related tooling is given, as requested by Buyer.

6.2 Seller shall ensure Seller's STE drawings of any electrical, electronic, hydraulic or pneumatic type, at a minimum, consist of a schematic with component parts called out by characteristics and/or part number, including adequate calibration and operation instructions.

### **7.0 CALIBRATION AND RE-CALIBRATION OF BUYER-FURNISHED OR SELLER-FABRICATED STE**

7.1 Seller shall develop and maintain a schedule for maintaining calibration of Buyer-furnished or Seller-fabricated STE. Seller's schedule is subject to approval of Buyer's representative and Seller shall ensure such schedule includes the following:

- Name and function of test equipment
- Serial or identification number of test equipment

- Criteria or standard to which test equipment is checked
- Frequency of test

7.2 Buyer shall determine mode of transportation for STE and make arrangements for shipment, when STE is required at another location.

**8.0 TOOLING USE AND TOLERANCE REQUIREMENTS** – Seller shall comply with the tool usage and tolerance requirements as defined in PM-4053, unless unique requirements are otherwise specified on the Statement of Work (“SOW”), BTP, or this PO.

**9.0 QUALITY ASSURANCE REQUIREMENTS OF SELLER-OWNED OR SELLER-FABRICATED PRODUCTION TOOLING**

9.1 Seller shall submit applicable data of all Seller-fabricated or Seller-owned production tooling to Buyer’s Program Management for review and approval prior to release of tool for trial run or First Article Inspection (“FAI”). Such data may include, but is not limited to, engineering data, drawings, designs, Master Layouts (“MEL”), etc. In addition, Seller shall use data generated by Trial Run to satisfy Buyer’s FAI requirement, if witnessed by Buyer’s Representative or designated alternate.

9.2 Seller shall inspect all Seller-fabricated production tooling, which has been manufactured utilizing Buyer-furnished Control Media, by utilizing applicable tooling tolerances defined in PM-4053.

9.3 Seller shall inspect or re-verify subsequent parts produced utilizing Seller-fabricated production tooling to the criteria defined in PM-4053.

9.4 Seller shall ensure each Item manufactured with Seller-fabricated ST and STE is identified in a conspicuous place with the current part number and dash number, Tool Code, any peculiar tool number, the “Also Use” current part number (if applicable), and/or Engineering Change Notice (“ECN”). Seller shall identify STE and MKT as “Property of USGOVT” and ST as “Property of Seller”, or as directed by this PO.

**END OF PART III**

## **PART IV APPENDICES**

### **APPENDIX A – REWORK, REPAIR AND COORDINATION GUIDE**

#### **1.0 GENERAL**

1.1 This Appendix A is applicable for all programs at all sites and is included in this Manual as specification guidance for the preservation, rework, repair and coordination of Buyer-furnished tools.

1.2 This Appendix A is provided as specification requirements for performing new make, rework, repair or coordination of Buyer-furnished tools.

- \* 1.3 This Appendix A is not all inclusive of tool preservation, repair and coordination requirements. Complete tool preservation, repair and coordination of Buyer-furnished tools are fully defined in the following paragraphs and PM-4053, Section 3.16. This Manual is intended to be utilized in conjunction with the requirements set forth in PM-4053.

#### **2.0 PRESERVATION OF BUYER-FURNISHED TOOLS**

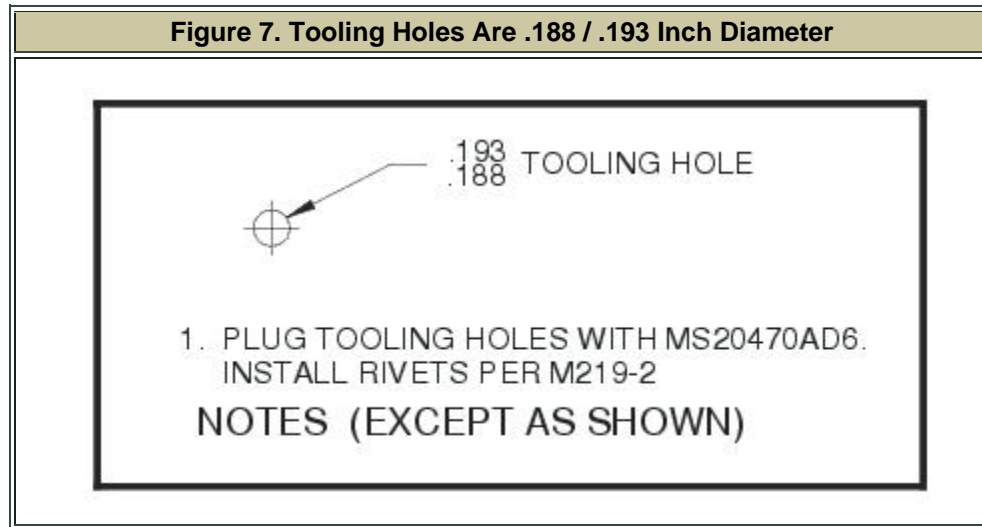
- \* 2.1 To ensure the preservation of Buyer-furnished tools, Seller shall:
- Provide adequate storage space to ensure Buyer Furnished tooling is not abused, stacked, constrained or uncontrolled in a manner that may contribute to a loss of configuration.
  - Maintain all Buyer-furnished tools in a rust-free and/or non-contaminated condition before shipping, storing or placing into production.
  - Use, store inside a building and handle with care at all times all fiberglass and composite tooling to prevent accidental damage to critical points, surfaces, holes, etc.
  - For fiberglass and composite tools stored in a controlled area other than 75 degrees +/- 10 degrees, protect such tools from excessive adverse conditions of heat, cold, sunlight, and moisture. In addition, when fiberglass and composite tools are subject to temperatures outside these limits, use such tools only after a period of temperature stabilization.
  - A period of 24 hours stabilization is required for each 10 degree change from 75 degrees and necessary to bring the tool back within the approved temperature limits, not to exceed 72 hours.
  - Apply a MIL-C-16173 Grade 2 protective coating to unpainted alloy surfaces if stored sheltered from the elements, and a MIL-C-16173 Grade 1 protective coating if stored exposed to the elements.
  - Apply a protective coating per MIL-P-3038 to plywood, Masonite, etc. if stored exposed to the elements.

2.2 Seller shall provide storage containers for all Master Tooling and Inspection Gages fabricated with Buyer tool numbers. Seller shall provide containers to specifications identified on the tool design. Seller shall ensure the containers provide adequate support and protection of tools from the environment and mishandling during movement.

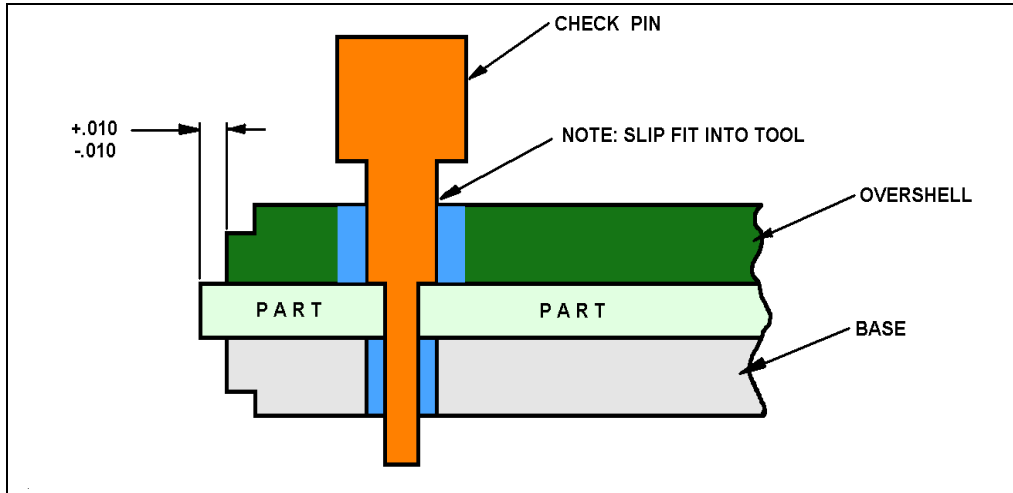
#### **3.0 STANDARD REPAIR, TOLERANCES AND COORDINATION**

- \* 3.1 For standard repairs, tolerances and coordination of Buyer-furnished tools, Seller shall:

- Produce tooling holes in Production Items as authorized and shall have a hole size tolerance of  $+.005/-0.000$  and are located within one-half of such tolerance.
- Locate and identify tooling holes on Item(s), as directed by Buyer, or illustrated in Figure 7. When Seller must plug tooling holes, Seller shall provide a general note to that effect as illustrated in Figure 7.

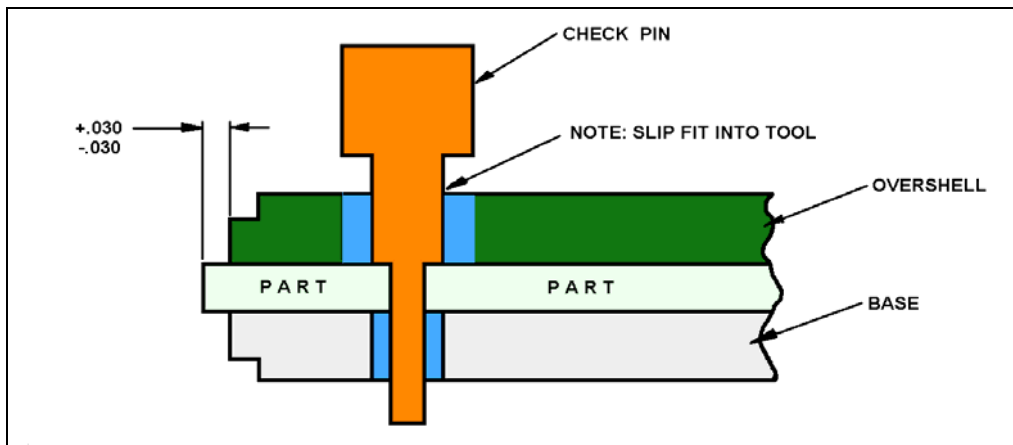


- Maintain allowable production tolerances on interchangeable Items produced/verified with controlled production tooling as illustrated in Figure 8.
- Utilize a check pin for all I/R hole patterns to ensure patterns are made in accordance with the tool coordination tolerance tables included herein.
- Utilize controlled production tooling to check and verify allowable production tolerances on interchangeable Items are from .010 smaller to .010 larger than the tool, as illustrated in Figure 8.
- Utilize a check pin to check and verify the I/R hole pattern is made in accordance with the tool coordination tolerance tables included herein.

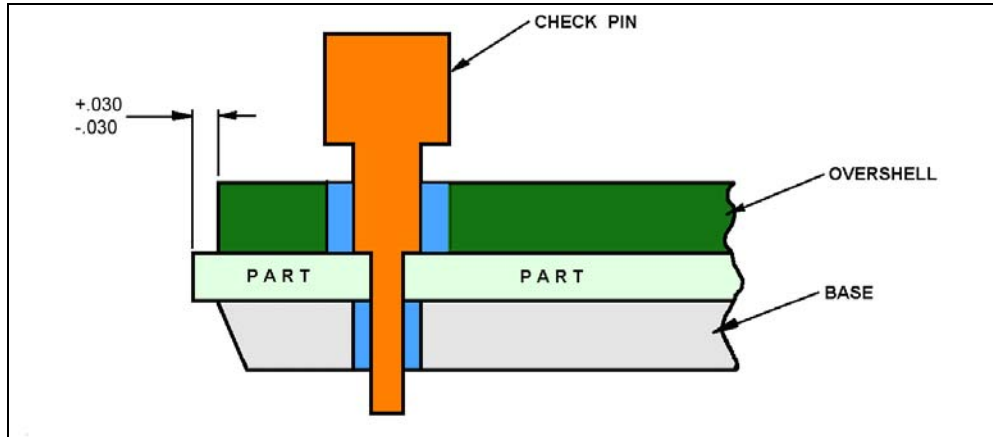


**Figure 8. DOUBLE RAIL (INTERCHANGEABLE)**

- Verify replaceable and non-I/R part perimeters produced with production trim tools or check fixtures have allowable production tolerances from a maximum of .030 smaller, to a maximum of .030 larger than the tool, relative to the engineering drawing applicable feature tolerance as illustrated in Figure 9 and 10.
- Verify perimeters are plus or minus .030 tolerances, unless otherwise stated on face of drawing. Example: An E.O.P. dimensioned as  $+.015$ ,  $-.030$  from a F.S., W.L., B.L. would apply. A "Tab" dimensioned as  $+$  or  $-.010$  for overall width, would apply if stated on the drawing.
- Utilize a check pin to verify all I/R hole patterns are made in accordance with the tool coordination tolerance table.



**Figure 9. DOUBLE RAIL (REPLACEABLE, AND NON I/R, NET OR WITH EXCESS)**



**Figure 10. SINGLE RAIL SETBACK TYPE (REPLACEABLE, AND NON I/R, NET OR WITH EXCESS)**

\*\* 3.1.1 Unique Tolerances for Legacy Program Tool Holes and Excess Material as specified

- Non-Designed C-130 and P-3 tools that are controlled by Tooling Tools, shall have a hole size tolerance of  $+0.001$  to  $-0.000$  and Pin tolerance for such tools shall be  $-0.0025$  to  $-0.0030$  per PM-4053 or as specified by this PO or Tool Design, if any or as directed by Buyers Program Engineering. Seller shall submit E-SPaR when discrepancies exist.
- Tooling holes may be authorized for detail parts manufacturing or location control during assembly and may or may not appear on engineering drawing. Sellers shall place tooling holes in detail parts only after authorization from Buyer's Program Engineering to avoid potential interference with subsequent installations.
- Material excess tolerance shall be per PM-4053 specification or as Buyer authorized through this PO to allow deviation from standard tolerance for part manufacturing. Standard tolerance of  $+0.060/-0.030$  when material excess call out is  $.100$  up to  $.250$ . For material excess greater than  $.250$ , the tolerance shall be  $+0.100/-0.060$ .

3.2 For tool inspection requirements of I/R tool coordination (applicable to new make, rework and coordination orders), Seller shall only utilize check pins which are AISI01 tool steel with a heat treat callout of RC 55-65 for pins with a diameter of  $.2500$  or larger, and a RC 38-48 for pins with diameters smaller than  $.2500$ .

3.2.1 For Control Tool to Production Tool Coordination – Seller shall pin the control tool to the tool being coordinated with  $.0000$  to  $.0005$  undersize pins at four(4) locations reasonably close to the corners of the control tool. Seller shall inspect the remaining holes in accordance with pin tolerances shown in Table 2.0 for “Coordination Check of Control Tools”.

3.2.2 For Control Tool to Control Tool Coordination (Make New) – Seller shall install new control tool bushings utilizing pins with  $+0.0000/-0.0002$  tolerance on diameter (Ref.: Transfer of hole pattern, Table 1.0).

3.2.3 For Control Tool to Control Tool Coordination (Rework) – During rework of control tools bushing, Seller shall install bushings utilizing pins with  $+0.0000/-0.0002$  tolerance on diameter. (Ref.: Table 1.0, Transfer of hole pattern).



- 3.2.4 For Control Tool to Control Tool (Coordination Check Only) – Seller shall check the control tool back to the tool it was made from. During coordination checks of control tools, (Example: MSGA to TOGA), Seller shall pin four corner holes utilizing pins with  $+.0000/- .0002$  undersize diameter. Ninety percent (90%) of the remaining holes are acceptable with  $.0000$  to  $.0010$  undersize diameter pins and the remaining ten percent (10%) of the holes are acceptable with  $+.0000/- .0025$  undersize diameter pins.
- 3.2.5 For Cross-Coordination of Control Tools – When duplicate control tools are fabricated, Seller shall cross-coordinate control tools in accordance with Table 1.0 "Coordination Check of Control Tools" to ensure compatibility.
- 3.2.6 For Bushing Installation – During the manufacture of new tools and reworks, Seller shall utilize tooling pins with  $+.0000/- .0002$  tolerance to install all tooling bushings (ref.: Table 1.0 and Table 2.0, Transfer of hole pattern).
- \* 3.2.7 For Inspection of Control Tool Bushing Wear – Seller shall inspect control tool bushings to ensure the maximum wear is limited in accordance with Table 1.0 and Table 2.0. Seller shall not use any control tools where bushing wear exceeds the maximum wear tolerance of  $+.0010$  on the inside diameter.

**NOTE: During tool use activities, control tool bushing wear can occur.**

**Table 1.0 Coordination Check of Control Tools**

HOLES UNDER .250	STRAIGHT PINS	HOLES .250 AND OVER
Nominal $+.0001/+ .0004$ Nominal $+.0000/- .0002$	<b>Transfer of Hole Pattern</b> Bushing I.D. Tolerance Pin Tolerance	Nominal $+.0001/+ .0006$ Nominal $+.0000/- .0002$
Nominal $+.0001/+ .0010$ Nominal $-.0015/- .0020$	<b>Cross Coordination / Coord. Check of Control Tools</b> Bushing I.D. Tolerance Pin Tolerance	Nominal $+.0001/+ .0010$ Nominal $-.0020/- .0025$
	STEP PINS	
Nominal $+.0001/+ .0004$ Nominal $+.0000/- .0002$ Nominal $+.0000/- .0002$ .0005 Max	<b>Transfer of Hole Pattern (New Make)</b> Bushing I.D. Tolerance Lg. Dia. Pin Tolerance Sm. Dia. Pin Tolerance Concentricity	Nominal $+.0001/+ .0006$ Nominal $+.0000/- .0002$ Nominal $+.0000/- .0002$ .0005 Max
Nominal $+.0001/+ .0010$ Nominal $-.0000/- .0002$ Nominal $-.0015/- .0020$	<b>Cross Coordination / Coord. Check of Control Tools</b> Bushing I.D. Tolerance Lg. Dia. Pin Tolerance Sm. Dia. Pin Tolerance	Nominal $+.0001/+ .0010$ Nominal $-.0000/- .0002$ Nominal $-.0020/- .0025$

**Table 2.0 Coordination Check of Production Tools**

HOLES UNDER .250	STRAIGHT PINS	HOLES .250 AND OVER
Nominal +.0001/+.0004 Nominal +.0000/-.0002 Nominal +.0001/+.0004	<b>Transfer of Hole Pattern (New Make)</b> C/T Bushing I.D. Tolerance Pin Tolerance P/T Bushing I.D. Tolerance	Nominal +.0001/+.0006 Nominal +.0000/-.0002 Nominal +.0001/+.0006
Nominal +.0001/+.0010	<b>Coordination Check of Control Tools to Prod. Tools</b> Bushing I.D. Tolerance	Nominal +.0001/+.0010
	STEP PINS	
Nominal +.0001/+.0004 Nominal +.0001/+.0004 Nominal +.0000/-.0002 Nominal +.0000/-.0002 .0005 Max	<b>Transfer of Hole Pattern (New Make)</b> C/T Bushing I.D. Tolerance P/T Bushing I.D. Tolerance Lg. Dia. Pin Tolerance Sm. Dia. Pin Tolerance Concentricity	Nominal +.0001/+.0006 Nominal +.0000/-.0006 Nominal +.0000/-.0002 Nominal +.0000/-.0002 .0005 Max
Nominal +.0001/+.0010 Nominal +.0000/-.0002 Nominal -.0020/-.0025 .0005 Max	<b>Coordination Check of Control Tools to Prod. Tools</b> Bushing I.D. Tolerance Lg. Dia. Pin Tolerance Sm. Dia. Pin Tolerance Concentricity	Nominal +.0001/+.0010 Nominal +.0000/-.0002 Nominal -.0030/-.0035 .0005 Max
Nominal +.0000/-.0002 Nominal +.0001/+.0004 .0003	<b>Additional Production Tool Tolerances</b> O/D of Slip Bushing I/D of Slip Bushing Concentricity O/D to I/D	Nominal +.0000/-.0002 Nominal +.0001/+.0006 .0003
Nominal +.0000/-.0002 Nominal -.0010/-.0012 .0005 Max	<b>Hinge Line Tool Tolerances</b> Pins for End Hinges Pins for Middle Hinges Concentricity (end & middle)	Nominal +.0000/-.0002 Nominal -.0010/-.0012 .0005 Max

3.3 Seller shall utilize step pins, as illustrated in Table 3.0, to perform a verification check of production items to production tools. Seller shall ensure the check-pin diameter is made to the low engineering range of the hole diameter being checked with the pin diameter tolerance as shown in Table 3.0.

**Table 3.0 COORDINATION CHECK OF PRODUCTION TOOLS**

HOLES UNDER .250	STEP PINS	HOLES .250 AND OVER
Nominal +.0001/+.0010 Nominal +.0000/-.0002 Nominal +.0000/-.0030 .0005 Max	Coordination of Production Parts to Production Tools (Using Step Pins)  P/T Bushing I/D Tolerance Lg. Dia. Pin in Tool Sm. Dia. Pin in Part Concentricity	Nominal +.0001/+.0010 Nominal +.0000/-.0002 Nominal +.0000/-.0030 .0005 Max

C/T - CONTROL TOOL P/T - PRODUCTION TOOL	I/D - INSIDE DIAMETER O/D - OUTSIDE DIAMETER
---	---

\* 3.4 Seller shall verify I/R tooling tolerances are as follows:

- Master Tooling is net (nominal).
- Master Tooling to Production Tooling for trim and contour shall be +/- .015 over 80% of gauging surface and +/- .020 over 20% of the surface per PM-4053.
- Production Tool to production Item for edge and/or cutout trim is +/- .010, except replaceable edges, net or with excess, which shall be +/- .030, unless otherwise stated on the engineering drawings.
- Production Tool to production Item tolerance for contour is .000 to +.020.

Note: This tolerance is a tooling application which recognizes the engineering drawing tolerance of +/- .010, unless otherwise specified, for sheet metal Item contour relative to Item being placed against a solid tool surface for checking. The tooling application also recognizes restraint in the tool, in accordance with the engineering drawing.

- Indenture tool development does not exceed +/- .005 total back to the master.
- Buyer-furnished Master Control Tooling is not used for production purposes, i.e., Item verification, trimming, drilling, and forming.

\* 3.5 Seller shall verify non-I/R tooling perimeter, holes and contour tolerances are as follows:

- Non I-R Tooling Tools are net to engineering, unless otherwise identified on tool, i.e., excess on a tooling sample. Excess tolerance shall be per PM-4053 specification or as Buyer authorized through this PO to allow deviation from standard tolerance.

- Tolerance from tooling tool to controlled production tooling is +/- .015" tolerance allowable over 80% of the gauging surface, and +/- .020" over 20% of the gauging surface as illustrated in Figure 6.0.
- Tolerance from controlled production tooling to production Item equals +/- the engineering drawing tolerance, for edge and/or cutout trim and holes.
- Controlled production tool to production Item tolerance for contour is .000 to +.020.

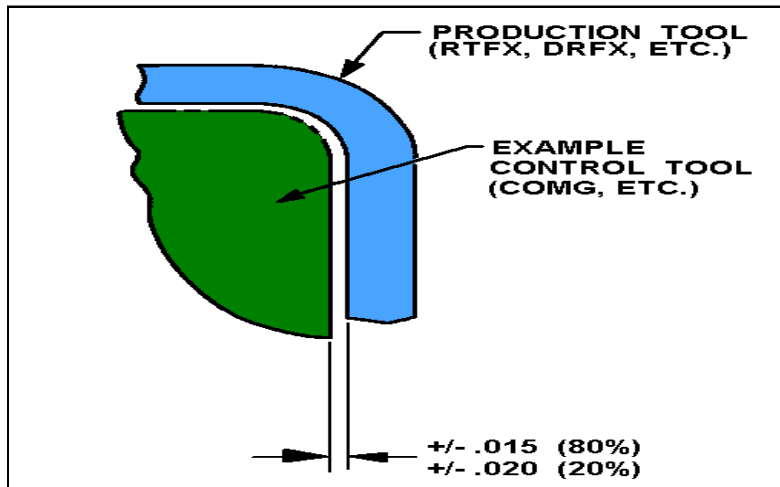
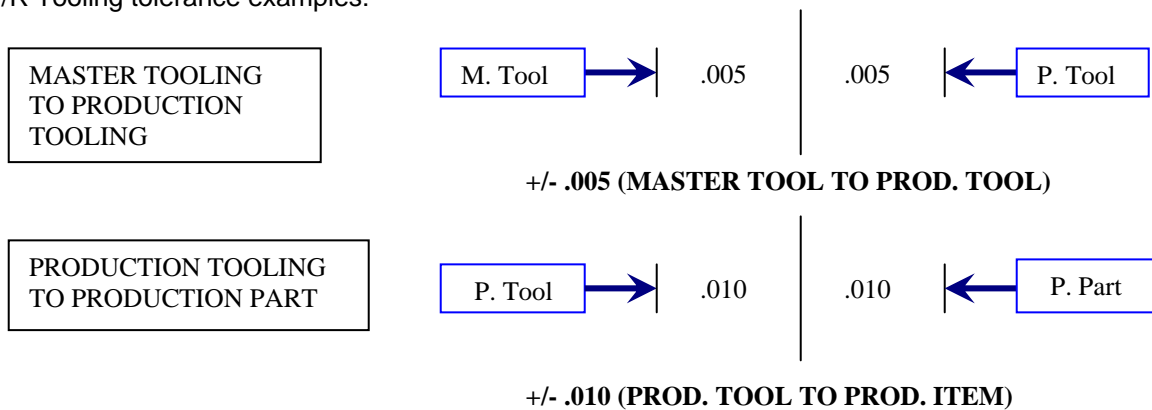


Figure 11. Production Tool to Control Tool

3.6 Seller shall verify Seller-developed tools yield an Item not to exceed +/- .010 variance from applicable Master Control Tooling.

3.7 Seller shall verify coordinated tool holes are direct pinning without undue interference.

3.8 I/R Tooling tolerance examples:



**END OF APPENDIX A**

**END OF TMS-MC-015 MANUAL**